

# Guide to Fumigation Under Gas-Proof Sheets

J.E. van Someren Graver

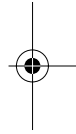

Food and Agriculture Organization of the United Nations

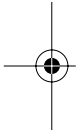
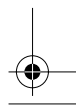
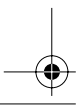

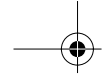

**Disclaimer:**

The text of this guide draws on a multimedia CD-ROM presentation with the same title. It is strongly recommended that it be used in conjunction with the electronic version, which contains more-comprehensive illustrative material, including video footage, on the procedures and techniques involved in undertaking safe and effective fumigation.

The information presented in the guide and CD-ROM is intended for people interested in learning more about fumigation. FAO has taken all reasonable care in producing the documents, which it believes were accurate at the time of initial publication or last modification. However, circumstances do change over time and FAO cannot accept responsibility for errors or omissions. Users are advised to verify the details contained in the guide and CD-ROM with the relevant national authority before making decisions based on the published information.

© FAO 2004. The copyright of information contained in the guide and CD-ROM is owned by FAO. All rights reserved.

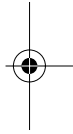

Produced for FAO by the Australian Centre for International  
Agricultural Research, Canberra

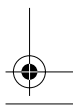
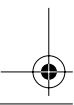



## Contents

<b>1</b>	<b>Introduction</b>	<b>1</b>
1.1	What is this fumigation guide for?	1
1.2	Who is this fumigation guide meant for?	1
<b>2</b>	<b>Fumigation – the basic facts</b>	<b>3</b>
<b>3</b>	<b>Good fumigations – who is responsible?</b>	<b>13</b>
3.1	Customers and their responsibilities	13
3.2	Fumigators and their responsibilities	14
3.3	Transport contractor(s) and their responsibilities	15
3.4	Regulatory agencies	16
3.5	Other parties that may be involved with fumigation	17
<b>4</b>	<b>Best fumigation practice</b>	<b>18</b>
<b>5</b>	<b>Monitoring</b>	<b>21</b>
5.1	Monitoring equipment	21
5.2	Measuring fumigant concentrations in the health and safety range	22
5.3	Measuring fumigant concentrations in the insecticidal (fumigation) range	23
5.4	Gas detector tubes	26
5.5	Electronic gas-measuring equipment	27
5.6	Using electronic gas detectors	28
5.7	Dosimeters	29
<b>6</b>	<b>Choosing the correct fumigant – phosphine or methyl bromide?</b>	<b>31</b>
6.1	Fumigation properties of methyl bromide and phosphine	31
6.2	Advantages and disadvantages of methyl bromide and phosphine	33

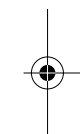



---

**GUIDE TO FUMIGATION UNDER GAS-PROOF SHEETS**

---

<b>7</b>	<b>Sheet fumigation</b>	<b>35</b>
7.1	Requirements for effective fumigation	35
7.2	Planning for fumigations	39
7.3	People needed to do a fumigation	42
7.4	The danger (exclusion, hazard or risk) area	45
7.5	Monitoring fumigant concentrations	47
7.6	Gas sampling tubing	49
7.7	Specifications for fumigation sheets	51
7.8	Products in impervious wrappings, surfaces and coatings	53
7.9	Methods for safe storage and handling of gas cylinders	54
7.10	Enclosing (sheeting) a stack	56
7.11	Metric/imperial conversions for fumigators	63
7.12	Volume of the fumigation enclosure	64
7.13	Sealing fumigation sheets to the floor	65
7.14	Container fumigation	70
<b>8</b>	<b>Fumigating with phosphine</b>	<b>75</b>
8.1	The requirements for successful fumigation with phosphine	75
8.2	The properties of phosphine as a fumigant	77
8.3	Safety rules for fumigators using phosphine	81
8.4	Personal-protection equipment for use during phosphine fumigations	87
8.5	Safety precautions	91
8.6	First aid	94
8.7	Phosphine dosage rates	96
8.8	Introducing phosphine into an enclosure	99
8.9	Monitoring for phosphine	104
8.10	Fumigation of small quantities of grain with phosphine	104
8.11	Disposal of spent aluminium-phosphide residues	109
<b>9</b>	<b>Fumigating with methyl bromide</b>	<b>110</b>
9.1	The requirements for successful fumigation with methyl bromide	110
9.2	The properties of methyl bromide as a fumigant	112
9.3	Safety rules for fumigators using methyl bromide	115
9.4	Personal-protection equipment for methyl bromide fumigation	120
9.5	Methyl bromide health-hazard information	124
9.6	Effect of methyl bromide on the commodity being fumigated	126





---

## GUIDE TO FUMIGATION UNDER GAS-PROOF SHEETS

---

9.7	Methyl bromide dosage rates	128
9.8	Introducing methyl bromide into an enclosure	129
9.9	Fumigation temperatures	131
9.10	Equipment specifically required for methyl bromide fumigation	132
9.11	Methyl bromide supply system	137
9.12	Specifications for delivery pipes and their layout	140
9.13	Monitoring for methyl bromide	142
9.14	Fumigation of loaded freight containers with methyl bromide	143
9.15	Minimum methyl bromide concentrations and topping-up	144
9.16	Methyl bromide and the ozone layer	150
<b>10</b>	<b>Aeration and clearance after a fumigation</b>	<b>156</b>
10.1	Clearing the fumigant from the enclosure	157
10.2	Clearing the fumigant from fumigation equipment	160
<b>11</b>	<b>Fumigation failure</b>	<b>161</b>
11.1	Some reasons why phosphine fumigations fail	161
11.2	Some reasons why methyl bromide fumigations fail	162
<b>12</b>	<b>References</b>	<b>164</b>
12.1	Selected world-wide-web-based references	164
12.2	Selected printed references	165
<b>13</b>	<b>Acknowledgments</b>	<b>168</b>

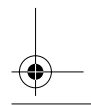
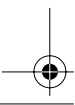
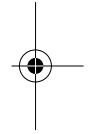
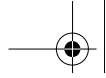



# 1 INTRODUCTION

## 1.1 What is this fumigation guide for?

This fumigation guide has been written to tell, and show, users how to do fumigations with the fumigants phosphine and methyl bromide using gas-proof sheets to treat:

- bag-stacks of grain and other commodities
- loaded freight containers
- other products or cargoes, such as timber and machinery, that can be enclosed under gas-proof fumigation sheets.

The information presented here is practical. There are few references to the scientific principles that support good and effective fumigation.

It has been assumed that the decision to fumigate has already been made after a consideration of all alternative infestation control methods available to the owner of the product or commodity to be fumigated (see Sections 9.6 and 12).



## 1.2 Who is this fumigation guide meant for?

This fumigation guide is designed for people who have had some training in how to do fumigations with phosphine and methyl bromide using gas-proof fumigation sheets.

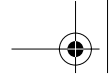

## GUIDE TO FUMIGATION UNDER GAS-PROOF SHEETS

---

It is **not** intended:

- as a training manual for people who have had no experience with fumigation
- that it replace any existing local regulations on use of phosphine or methyl bromide (or any other fumigants).

Where local regulations exist, this guide may provide a better understanding of these regulations and information on topics not covered by them.

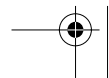
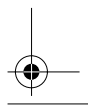
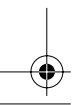
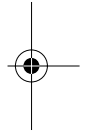





## 2 FUMIGATION – THE BASIC FACTS

- ▷▷▷ **Fumigants** are chemicals that are *gases* at normal temperatures. Because of their toxicity to organisms, they are used to kill pests. They very rapidly penetrate through grains and other commodities.

The way fumigant gases diffuse during a fumigation treatment depends on their *physical properties*. For this reason, it is essential that fumigators have a good understanding of fumigant properties, and how they can affect the result of a fumigation.

- ▷▷▷ **Fumigation** is the process of adding a fumigant to a *fumigation enclosure* with the specific objective of killing pests.

**Best fumigation practice** is the process that provides a successful treatment and *results* from a practical combination of all the procedures required during a fumigation treatment to ensure that:

- the people doing the fumigation remain safe and are not harmed
- all people in the area around the fumigation treatment area remain safe and are not harmed
- the environment is not harmed
- all life stages of all target pests are killed
- the commodity or product being treated is not damaged in any way.

Each of these five objectives, which make up a successful fumigation, will happen when **best fumigation practice** is followed wherever a fumigation treatment is done.

- ▷▷▷ **Fumigation enclosures** may be permanent or temporary structures. Regardless of this, they must be well-sealed, so that they are sufficiently gastight to hold a toxic concentration of a fumigant gas long enough to kill target pests during a specific period of time called *the exposure period*.



## GUIDE TO FUMIGATION UNDER GAS-PROOF SHEETS

In **best fumigation practice**, fumigation enclosures are checked to ensure that they are sufficiently well-sealed to hold a fumigant over the required exposure period(s).

Permanent fumigation enclosures include purpose-built fumigation chambers, some sealed grain silos, some sealed horizontal grain storages etc.

Temporary fumigation enclosures are most commonly created using gas-proof plastic sheets, using a technique called sheet fumigation (or, in the USA, fumigation under tarpaulins/tarps). Sheet fumigation is the technique most commonly used to disinfest bagged grain (and other commodities), freight containers, and whole buildings.

- ▷▷▷ In **best fumigation practice**, temporary fumigation enclosures are created on a gas-proof floor using plastic gas-proof fumigation (cover) sheets to ensure that they can hold a toxic concentration of a fumigant gas over the whole of the required exposure period. Where the floor is not gas-proof, it should be coated with a suitable gas-proof paint or covered with a gas-proof floor sheet.

Fumigation can also be carried out under prefabricated plastic sheets that are joined together using a plastic zip. Such enclosures are called fumigation bubbles, storage cubes or cocoons. They provide a higher degree of sealing than do ordinary fumigation sheets, and can be tested to prove that they are sufficiently well-sealed to hold a fumigant over the required exposure period(s).

- ▷▷▷ **The exposure period** is the time required for a specific dosage of fumigant to kill target pests. For practical purposes, the exposure period does not start until monitoring shows that the concentration of fumigant gas inside the fumigation enclosure has reached an effective concentration (for example, 0.05 g/m<sup>3</sup> for phosphine and 3 g/m<sup>3</sup> for methyl bromide) throughout the enclosure (this is often called the minimum effective, or equilibrium, concentration).

The exposure period must be long enough for the fumigant gas to reach a toxic concentration in the atmosphere surrounding the target pest. The length of the exposure period differs, depending on the:

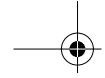

## GUIDE TO FUMIGATION UNDER GAS-PROOF SHEETS

- fumigant being used
- most tolerant stage or physiological state (diapausing or active) of the target pest
- temperature of the commodity or product that has to be fumigated
- rate of respiration (breathing) of the target pest
- dosage of fumigant applied into the fumigation enclosure.

▷▷▷ **Half-loss time (HLT)** is the time taken for one half of the original concentration of fumigant to be lost from a fumigation enclosure due to leakage or sorption.

The HLT is an important and useful way of finding out if gas loss will be so great that a required endpoint concentration will not be achieved.

The HLT can be determined only by monitoring gas concentrations during the exposure period.

▷▷▷ **Fumigation sheets (gas-proof sheets, tarpaulins or tarps)** are gas-retaining plastic sheets used to hold fumigant gases inside a fumigation enclosure during the exposure period.

▷▷▷ **Sealing** is the process of making a fumigation enclosure gastight:

- to make sure that fumigant gas loss (leakage) is minimised
- so that sufficient gas is available over the full time of the required exposure period.

It is recognised that a certain amount of leakage will occur, even from well-sealed enclosures, but this must be reduced to the lowest practical point.

▷▷▷ **Leakage** is loss of fumigant gas from a fumigation enclosure.

▷▷▷ **Permeation** is loss of fumigant gas from a fumigation enclosure through 'gas-proof' sheets, which are seldom completely impermeable.

▷▷▷ **Diffusion (dispersion)** is the process whereby a fumigant gas moves from an area of high concentration to an area of lower concentration, ending with an equilibrium concentration.

Fumigant gases are dispersed inside fumigation enclosures by air currents generated by (i) density differences, (ii) natural air movement

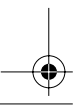
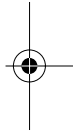



## GUIDE TO FUMIGATION UNDER GAS-PROOF SHEETS

when hot and cold gases mix, and/or (iii) forced air movement using fans.

Fumigants diffuse as separate molecules. This allows them to penetrate into materials to be fumigated and then out of them at the end of the exposure period during aeration of the commodity.

The speed of diffusion increases as the temperature rises. Diffusion is one of the processes by which gas loss/leakage out of a fumigation enclosure occurs, and may be greatly increased by factors including wind-induced concentration gradients and movement of enclosure sheets, and heating.

The time taken for a fumigant gas to diffuse depends on its density. The lighter the gas, the faster it diffuses. Thus, phosphine diffuses more rapidly than methyl bromide, which is heavier than phosphine.

▷▷▷ **Dosage** describes the amount of fumigant gas that must be introduced into a fumigation enclosure and the length of the exposure period.

A dosage is always expressed in two parts: (i) a statement indicating the *amount of fumigant gas required* and (ii) a statement giving a *period of time* (the exposure period).

The amount of fumigant gas required may be presented in two ways:

- as *an amount of fumigant gas per unit of volume* of space/ enclosure, usually given as grams per cubic metre, which is abbreviated as **g/m<sup>3</sup>**
- as *an amount of fumigant gas per unit of weight* of commodity, usually given as grams per tonne, which is abbreviated as **g/t**.

This figure is always followed by a second statement giving the length of the exposure period in hours (or usually days in the case of phosphine). For example, by stating the concentration followed by the exposure period **x g/m<sup>3</sup> for 24 hours** or **y g/t for 7 days**.

▷▷▷ **Equilibrium** occurs in well-sealed enclosures – after the dosage is applied – when the gas concentration remains stable and equal in all parts of the fumigation enclosure (within a specified range, e.g. plus





## GUIDE TO FUMIGATION UNDER GAS-PROOF SHEETS

or minus 25%) and remains above an established threshold for tolerant life stages of target pests.

Inability to achieve equilibrium at an effective concentration usually results in poor insect control or fumigation failures due to the occurrence of areas of low fumigant concentration.

**In best fumigation practice, the exposure period is judged to start only after monitoring has indicated that equilibrium, at an effective concentration, has been reached.**

▷▷▷ **Concentration** describes the amount of fumigant in the air/atmosphere inside a fumigation enclosure during the exposure period, or in the workspace around a fumigation enclosure, and is an expression of the weight or volume of fumigant gas in a given volume of air.

The units of concentration are usually: grams per cubic metre ( $\text{g}/\text{m}^3$ ), milligrams per litre (mg/L) or parts per million (ppm).

With fumigants, ppm describes the volume of fumigant gas per million volumes of air, e.g. litres per million litres (or microlitres per litre).

Measurements of fumigant gases *in the workspace* are usually given in ppm because they are not affected by changes in temperature and pressure.

**Measurements in ppm are *not* equivalent to measurements in units such as mg/L or  $\text{g}/\text{m}^3$ .**

▷▷▷ **Monitoring** is the process of measuring the concentration of fumigant gas inside a fumigation enclosure and in the area surrounding a fumigation enclosure. Monitoring gas concentrations inside a fumigation enclosure allows the fumigator to:

- check if the correct quantity of gas has been introduced into the fumigation enclosure

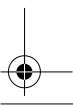
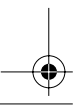
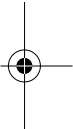

## GUIDE TO FUMIGATION UNDER GAS-PROOF SHEETS

- determine when the gas inside the fumigation enclosure is evenly distributed, and when to start timing the exposure period
- check if the fumigant is leaking out of the enclosure
- make dosage corrections to ensure that the fumigation treatment will be successful
- determine if and when the target endpoint gas concentration has been reached.

Monitoring the gas concentrations in the area surrounding a fumigation enclosure allows the fumigator to:

- ensure that fumigant concentrations *in the workspace* are safe to work in and do not exceed the *threshold limit value* (TLV)
- ensure that fumigant concentrations in the fumigated commodity do not exceed the TLV at the end of the exposure period when it is *aired* to allow *desorption* of the fumigant gas so that the commodity can be safely handled.

**If you are not monitoring, you are not fumigating!**

▷▷▷ **The threshold limit value (TLV) (occupational exposure standard)** is the figure established for the maximum concentration of fumigant gases to which workers may be repeatedly exposed in the workplace without harmful effects. This figure is based on an 8-hour per day, 40-hour working week.

The TLV values are for inhalation only and do not include intake of fumigant gases through the mouth, skin or eyes.

TLVs have been established for all fumigants. These are essential worker and workplace health and safety guides, and must be clearly understood and acted on by all persons involved in a fumigation.

In many countries the TLV (or health and safety limit) has been set at:

- 0.3 ppm (0.0004 g/m<sup>3</sup> or 0.42 mg/m<sup>3</sup>) for **phosphine**
- 5.0 ppm (0.02 g/m<sup>3</sup> or 19.4 mg/m<sup>3</sup>) for **methyl bromide**.



## GUIDE TO FUMIGATION UNDER GAS-PROOF SHEETS

- ▷▷▷ **Sorption (absorption and adsorption)** is uptake of fumigant gas by the product being fumigated. Sometimes this can be so great that the amount, or concentration, of fumigant gas available inside a fumigation enclosure is reduced to less than the minimum effective concentration. When this happens, it becomes impossible to kill the target pests.

**If this situation is not corrected by addition of more gas (called 'topping-up' or 'dosage correction'), the treatment will fail.**

**Best fumigation practice** involves (i) being aware of commodities and products known to sorb large quantities of fumigant gases (for example grains and oilseeds with a high oil and/or moisture content), and (ii) considering the use of an alternative fumigant that is either not sorbed or sorbed to a lesser extent.

Fumigants with high boiling points (methyl bromide, for example) tend to be sorbed more than fumigants with low boiling points (phosphine, for example).

There are two types of sorption, physical and chemical, the latter giving rise to residues in the treated commodity. Whereas chemical sorption is reduced at low temperature, physical sorption is increased, and to a much greater extent. This, in addition to increased pest tolerance, is a reason why dosages must be increased when fumigations are done at low temperatures.

**Best fumigation practice** requires fumigators to understand all the processes that can influence sorption and formation of *residues*.

- ▷▷▷ **Desorption** is the reverse of sorption. It is the release of sorbed fumigant gas from the product that was fumigated. Desorption generally occurs at the end of a fumigation exposure, as the fumigant escapes or disperses out of the product during the *aeration* or ventilation stage of a fumigation treatment.

Fumigants with high boiling points (e.g. methyl bromide) tend to be sorbed more and remain as *residues* for longer times than fumigants with low boiling points (e.g. phosphine).

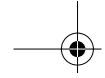

## GUIDE TO FUMIGATION UNDER GAS-PROOF SHEETS

---

Desorption can take a long time after a product has been fumigated at a low temperature, but is more rapid in products fumigated at high temperature and/or moisture content.

Desorption can be accelerated by increasing the flow of air through and around products that have been fumigated. This can be done at the end of the exposure period when the fumigation enclosure is opened and aerated, and may involve:

- use of fans to speed up air movement
- opening doors and windows to allow a free flow of air into and out of the warehouse.

The amount of residual fumigant gas left in a product after fumigation depends on:

- the conditions when the fumigation was done
- the length of the aeration period.

If excessive residual fumigant gas is left in a treated product, it can be dangerous for workers and other people if they come into contact with the desorbing gas.

**Best fumigation practice** requires fumigators to understand the processes that can influence *desorption*.

▷▷▷ **Residues** are the very small quantities of chemicals left in a product after it has been fumigated. Residues include one or more of the following:

- chemicals from which fumigant gases are generated (for example, aluminium phosphide formulations)
- fumigant gas (for example, unchanged methyl bromide after a fumigation done at low temperatures)
- any new chemical compound formed when a fumigant gas reacts with the product being fumigated (for example, bromide residues after a fumigation with methyl bromide).

International limits have been established for the maximum acceptable amount of residues that may be left in many products, particularly grains and foodstuffs.







## GUIDE TO FUMIGATION UNDER GAS-PROOF SHEETS

Fumigators must understand that residues can be formed during a fumigation treatment, and residue formation can be minimised by using the correct dosage, exposure period, and method(s) of applying the fumigant.

- ▷▷▷ **Aeration (airing or ventilation)** is the process at the end of the exposure period, after the fumigation enclosure is unsealed, when fumigant gas desorbs and diffuses out of:
- the product that was fumigated
  - the fumigation enclosure.

Aeration can be speeded-up by increasing the flow of air through and around the product that was fumigated by:

- opening warehouse doors and windows
- using fans to accelerate air movement.

After the concentration of fumigant in both the fumigation enclosure and the product that was treated has been shown by monitoring to have fallen to, or below, the TLV, it becomes safe for people to handle the product. Only when this stage is reached may *clearance* be issued.

- ▷▷▷ **Clearance** is the procedure after the aeration period when the fumigator tests the air in the workspace to make sure that the concentration of fumigant gas has fallen to or below the safe levels and declares the area safe for workers to enter a fumigated space and/or handle a fumigated product.
- ▷▷▷ **Danger (exclusion, hazard or risk) area.** Any area near to a fumigation enclosure into which fumigant gas may escape or diffuse in dangerous concentrations is called the danger area. This area must be clearly marked out in accordance with national or local government regulations.
- ▷▷▷ **The label.** In most countries, when it has been demonstrated that a chemical can be used in compliance with national regulations governing the use of insecticides, the chemical is registered for use and granted a *label* by a national agricultural chemicals registration agency.

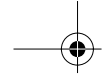

## GUIDE TO FUMIGATION UNDER GAS-PROOF SHEETS

---

The label provides specific information, instruction and advice to the user on how any registered chemical (including fumigants) should be used. For example:

- the product name
- the active constituents
- the name and address of the company that registered the product
- applications for which it is registered to be used
- directions for use (including when to use, when not to use, withholding period)
- general instructions (including resistance, how to mix, how to apply, how much to apply, how often to apply, how to prevent residues)
- precautions (including storage, disposal, protection of wildlife)
- safety directions
- first aid (including emergency contact telephone numbers)
- reference to material safety data sheet (see below)
- a registration agency approval number.

In **best fumigation practice** a fumigant should be used only in accordance with the instructions provided on the label.

If no label is attached to a fumigant container, it should not be used until the supplier can provide one. Failing that, further information should be sought from the relevant national agricultural chemicals registration agency.

- ▷▷▷ **Material safety data sheets (MSDSs)** describe the properties and hazards of a material or substance, including its identity, normal uses, ingredients, physical and chemical properties, stability and reactivity, health hazards, first aid treatment, storage, ecological information, and transport and disposal considerations.

In **best fumigation practice** a copy of the MSDS for the fumigant (and any other chemicals) being used should always be available *on-site* wherever and whenever a fumigation is undertaken.





### 3 GOOD FUMIGATIONS – WHO IS RESPONSIBLE?

The process of fumigation, *and its success*, are generally assumed to be the sole responsibility of the fumigator. When problems are encountered, and failures occur, these are usually considered to be the result of poor fumigation practice on the part of the fumigator. However, this is not always the case, because successful fumigation relies on all people involved in any fumigation treatment. They may include:

- the person or organisation requesting the fumigation service (the customer), the buyer, exporter or importer of the consignment to be fumigated
- the fumigator
- the transport contractor(s)
- regulatory agencies that directly affect the conduct of the fumigation.

When fumigation failures occur, they may be the result of factors *outside the fumigator's control*, but *within the control of one or more of the other parties* involved with the fumigation treatment. Though it may appear to be a simple procedure, fumigation is complicated. It needs careful planning and an understanding of the process by all parties involved so that it can be carried out effectively and safely.

Before starting a fumigation, *all* parties must be satisfied that they are aware of their responsibilities and have complied with all guidelines and industry codes, so that the fumigation can be performed by the fumigator with confidence, applying **best fumigation practice**.

#### 3.1 Customers and their responsibilities

The customer is the person, or organisation, requesting the fumigation treatment from the fumigator. This may be the owner of the commodity, an agent, a godown manager or an agent acting on behalf of a buyer, an exporter or an importer.

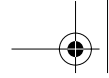

## GUIDE TO FUMIGATION UNDER GAS-PROOF SHEETS

**It is important that the customer presents the goods to be treated to the fumigator in an appropriate state to be fumigated with the fumigant of choice.**

The customer must:

- choose a properly qualified and trained fumigator holding nationally recognised, approved and currently valid certification to perform fumigations
- inform the fumigator, before performing the treatment, about any specific pest-control requirements for the consignment to be fumigated and about certification requirements
- ask the fumigator how the commodity should be prepared so that it can be fumigated effectively with the fumigant of choice
- make sure that sufficient time is available to perform an effective fumigation with the chosen fumigant and meet the requirements of a specific treatment (for example, a treatment to kill all life stages, including the diapausing larvae, of *Trogoderma granarium* (Khapra beetle))
- inform transport contractors that a product has been fumigated
- store commodities in a way that allows them to be fumigated effectively.

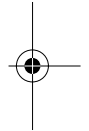
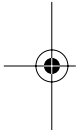

### 3.2 Fumigators and their responsibilities

The fumigator is the person or organisation that undertakes to perform the fumigation treatment. The fumigator must provide trained fumigation staff who are supervised, on-site, by at least one competent 'fumigator-in-charge', who will employ **best fumigation practice** to achieve a successful fumigation using the fumigant chosen.

The fumigators must be properly trained and qualified. They must:

- hold a valid licence or certificate – where required
- have the skills and competencies needed to undertake specified fumigation treatments, e.g. quarantine treatments with methyl bromide

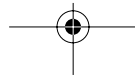



## GUIDE TO FUMIGATION UNDER GAS-PROOF SHEETS

- have fully functional and safe equipment with which to undertake fumigation treatments, including equipment required to accurately apply the *correct dosage* of fumigant, measure fumigant levels *in and around the workspace*, and *inside the fumigation enclosure*
- understand the requirements for a successful fumigation with the fumigant of choice
- recognise a fumigation failure when one occurs.

The fumigator must, before each fumigation:

- advise customers how to prepare the commodity for effective fumigation
- ask the customer about any specific conditions attached to the treatment
- tell the customer how much time is needed to successfully complete fumigation using the fumigant selected for the treatment
- tell the customer about any situation that could make the fumigation treatment impossible or unsuccessful – for example, if a commodity is stored in a way that would prevent a successful fumigation treatment, or where there is insufficient time to do a fumigation treatment using the long exposure periods required for treatments with phosphine
- issue all necessary notices and certificates relating to the treatment, aeration, and occupational safety involved with the fumigated commodity
- advise all relevant local authorities, e.g. police, fire brigade, and the nearest hospital.

### 3.3 Transport contractor(s) and their responsibilities

Transport contractors may include freight agents, and road, rail and sea transporters. They must:

- obtain from their customer and the fumigator information about the fumigation, including when the treatment was done, and the lengths of the exposure and aeration periods

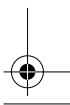
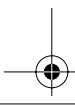
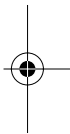



## GUIDE TO FUMIGATION UNDER GAS-PROOF SHEETS

- be aware that the cargo has recently been fumigated, or is still under in-transit treatment with a fumigant
- be aware of local, national and international regulations concerning transportation of fumigated consignments
- be aware of national and international legislative requirements regulating in-transit fumigation, if that is being considered or under way.

It is particularly important for transport contractors to be aware of the responsibilities involved in handling and transporting consignments that have recently been fumigated, and may still be giving off (desorbing) fumigant gas.

### 3.4 Regulatory agencies

Regulatory agencies include national and international agencies (e.g. quarantine authorities) with an interest in the way that fumigation treatments are done. This may be through legislation, regulation, training and retraining, and/or licensing.

#### National regulatory agencies

National regulatory agencies establish guidelines for safe working environments when fumigators perform fumigation treatments with methyl bromide and other fumigants. These may include, for example:

- guidelines and procedural requirements that have been compiled and include a requirement for training
- standards that relate specifically to fumigation and fumigation equipment that have been established.

#### International regulatory agencies

International regulatory agencies can affect the way fumigation treatments are performed by, for example:

- publishing information about national and international legislation, industry codes, and requirements for certification, to help raise fumigators' awareness of the standard of competence at which they must work

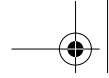

## GUIDE TO FUMIGATION UNDER GAS-PROOF SHEETS

---

- requiring fumigators to undertake fumigations to standards that differ from the standards established nationally, where the fumigation will be performed. This is frequently the case when fumigations are done for quarantine purposes when grains and other commodities are exported.

### 3.5 Other parties that may be involved with fumigation

The list above is not comprehensive. The people involved in a fumigation treatment may vary from place to place. For example, in some countries it is necessary to inform the police, the fire brigade, and the nearest hospital before starting a fumigation treatment. Irrespective of this, all the parties involved in a fumigation must clearly understand the reasons for their involvement and the need to fulfil the responsibilities of their involvement to ensure the successful outcome of the fumigation.

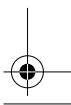
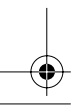
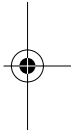

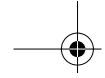

## 4 BEST FUMIGATION PRACTICE

**Best fumigation practice** is the result of a practical combination of all procedures required during a fumigation treatment to ensure that:

- the people doing the fumigation remain safe and are not harmed
- all people in the area around the fumigation treatment area remain safe and are not harmed
- the environment is not harmed
- all life stages of all target pests are killed
- the commodity, or product, or equipment being treated inside the fumigation enclosure is not damaged in any way.

Each of these five goals, that make up a successful fumigation, *will be* reached when **best fumigation practice** is followed.

**Best fumigation practice** as described in this fumigation guide may ask for conditions, requirements and resources that may be unavailable to the fumigator. In some cases, it may still be possible for a fumigator to do a fumigation. However, **as the technique moves further away from best fumigation practice:**

- ✘ the risk of harming people rises
  - ✘ the chances of killing target pests falls
    - ✘ until, at a certain minimum point, fumigation is not worthwhile
      - ✘ **BECAUSE IT WILL FAIL.**

When fumigations that do not follow **best fumigation practice** are done repeatedly, there is an unacceptable likelihood:

- of harming people in and around the fumigation area
- that insects will develop resistance to the fumigant used in such treatments.

This is because core parts of the fumigation technique essential for a successful result are not applied.





**GUIDE TO FUMIGATION UNDER GAS-PROOF SHEETS**

The table below lists some examples of conditions for **best fumigation practice** and those which are essential for safety during a fumigation.

If **any** of the conditions essential for safety cannot be met then fumigators and other people will be endangered.

	Conditions for best practice	Essential conditions for safety
Trained personnel available (licensed or registered where required)	✓	✓
Enclosure can be made gastight	✓	✓
Personal-protection equipment available	✓	✓
Method of monitoring workspace concentration available	✓	✓
People can be excluded from area close to fumigation	✓	✓
No connection (pipes, drains, ducts) between fumigation enclosure and a non-target area	✓	✓
Sufficient time available for post-exposure ventilation	✓	✓
Fumigant allowed under local legislation	✓	-
Fumigant acceptable to product end user	✓	-
Commodity not damaged by fumigant	✓	-
Adequate supply of fumigant available	✓	-
Adequate time for exposure period	✓	-
For phosphine: temperatures between 15 and 35°C.	✓	-
For methyl bromide: temperatures between 10 and 35°C	✓	-
Meteorological conditions acceptable e.g. minimal wind	✓	-

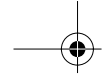

## GUIDE TO FUMIGATION UNDER GAS-PROOF SHEETS

---

There are many conditions that make up **best fumigation practice** and it is not possible to list them all in the table above. However, if any of the points listed are not met, then the fumigation will not reach the highest standards of safety and may not kill all life stages of all target pests.

Many of the requirements of **best fumigation practice** result from the 'science behind fumigation'.

However, there is also a very practical aspect to **best fumigation practice** that applies to the materials, equipment, and tools that fumigators use during a fumigation treatment.

Fumigators must remember that they are working with poisonous gases. For this reason they must always make sure that they are properly equipped. Fumigators must:

- have proper respiratory protective equipment available, either (i) self-contained breathing apparatus, or (ii) a respirator with filter canisters appropriate for the fumigant being applied
- have at a fumigation site a complete set of spanners that fit *exactly* onto cylinder valves and gas connections, because they do not damage them as do shifting/adjustable spanners; this can save lives when **working with cylinders** that contain fumigants
- always maintain fumigation monitoring equipment in good-as-new condition, because if you fail to have **gas-monitoring equipment** calibrated regularly (and in accordance with the manufacturer's instructions) this may be the cause of a fatal accident
- never make a temporary replacement, because it will almost always continue to be used, and could be a cause of reduced standards in your fumigation work.

Using **best fumigation practice** means that, whenever a fumigation treatment is done, proper attention is given to:

- occupational health and safety (OH&S), environmental and other regulatory requirements
- equipment and chemical manufacturers' specifications/instructions
- the client's requirements.

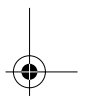
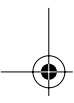
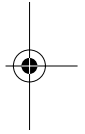



## 5 MONITORING

Monitoring is the process of measuring the concentration of fumigant gas:

- inside a fumigation enclosure
- in the area surrounding a fumigation enclosure.

Monitoring is done for two reasons:

- to be sure that workers and other people near the fumigation site are safe (health and safety)
- to measure the concentration and distribution of fumigant gas inside the enclosure (success of fumigation).

Each reason for monitoring has different requirements.

### *Monitoring for health and safety*

Health and safety monitoring is concerned with measuring concentrations of fumigant gases at about the TLV level, which in many countries has been set at:

- 0.3 ppm (0.0004 g/m<sup>3</sup> or 0.42 mg/m<sup>3</sup>) for **phosphine**
- 5.0 ppm (0.02 g/m<sup>3</sup> or 19.4 mg/m<sup>3</sup>) for **methyl bromide**.

### *Monitoring to ensure the success of fumigation*

The distribution of gas inside the enclosure and the success of the fumigation involve measuring insecticidal (or fumigation) concentrations of fumigant gases which range between:

- 0.1 and 5.0 g/m<sup>3</sup> (70 and 3500 ppm) for **phosphine**
- 2 and 100 g/m<sup>3</sup> (515 and 25,700 ppm) for **methyl bromide**.

### 5.1 Monitoring equipment

A wide variety of equipment is available for measuring phosphine and methyl bromide concentrations. The equipment used must be suitable for monitoring in the concentration ranges for:

- concentrations involved in the workplace
- the insecticidal concentrations reached during fumigation treatments.

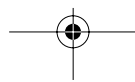
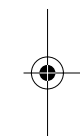



## GUIDE TO FUMIGATION UNDER GAS-PROOF SHEETS

Instruments for monitoring are available that can measure fumigant gas at:

- low concentrations only – for workplace safety (TLV) measurements
- high concentrations only – for checking the progress of fumigation exposures
- low and high concentrations – from the low safety concentrations to the high fumigation concentrations
- the range of concentrations over the whole of the exposure period – a process called dosimetry.

The range of instruments available extends from single-use gas detector tubes (for use either at safety or fumigation concentrations and dosimetry) to multipurpose electronic instruments.

### 5.2 Measuring fumigant concentrations in the health and safety range

Measuring phosphine and methyl bromide concentrations in the health and safety range (that is, around the TLV, which is **0.3 ppm for phosphine** and **5 ppm for methyl bromide**), is much more difficult than measuring the high concentrations found inside enclosures during fumigation treatments.

In many countries, the TLV (or a similar occupational health limit) has a legal status. Because of this, it is important to measure health and safety concentrations very accurately. More importantly, there is a risk to human health if inaccurate measurements are made.

When making measurements of fumigant gas concentrations in the health and safety range, fumigators must use:

- detector tubes that have been stored at the correct temperature (normally 5–25°C) for no longer than the 'shelf life' printed on their storage container(s)
- electronic (and other) gas-detection meters that are regularly and properly calibrated.

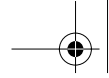

## GUIDE TO FUMIGATION UNDER GAS-PROOF SHEETS

If, during health and safety monitoring, there is any indication or suggestion that an electronic meter is inaccurate and giving wrong readings, it is safer to:

- take all extra precautions needed to work in areas where fumigant gas concentrations are suspected to be above the TLV
- totally ignore the meter's readings.

### 5.3 Measuring fumigant concentrations in the insecticidal (fumigation) range

The best way to predict if a fumigation will be successful is to show that the fumigant gas has:

- dispersed evenly throughout the enclosure
- reached an insecticidal concentration throughout the enclosure
- reached a required endpoint concentration.

In practice, this is done by measuring the concentration of the gas for at least three points inside the enclosure several times during the fumigation exposure period.

The gas samples are pumped out of the fumigation enclosure through tubing. The type and size of tubing used depends on local availability. However, the internal diameter must not be too large, because too large a volume of air would need to be pumped out of the gas-sampling tubing (purging) before a sample of the gas is obtained.

In practice, nylon hydraulic tubing with an internal diameter of 2–5 mm has been found to be very effective for this purpose. Care must be taken in bending nylon tubing, because if it is bent too much it can kink and get blocked.

The tubing must be:

- placed at the sampling points – before the sheets are put in place
- led to floor level and out of the enclosure – under the sheets
- sealed to the floor by the sand snakes weighting the sheets onto the floor
- made long enough to be sampled outside the danger area around the fumigation enclosure.

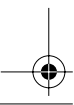
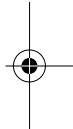
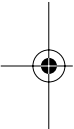



## GUIDE TO FUMIGATION UNDER GAS-PROOF SHEETS

Measurements of gas concentration during the exposure period tell the fumigator:

- if enough gas has been added to the enclosure
- when the gas inside the fumigation enclosure is evenly distributed (in equilibrium) and when to start timing the exposure period
- if gas is leaking out of the enclosure
- to look for and repair leaks, if safe
- to top up the dosage, if necessary and safe
- if the treatment has succeeded or failed.

### SAFETY NOTE

**Inspecting and/or adding more fumigant to an enclosure can be dangerous.**

**Respiratory protection and workspace monitoring are essential for these procedures.**

A critical time to measure the concentration of gas inside the enclosure is at the end of the exposure period, because this is the time when fumigators find out if the treatment has succeeded or failed.

It is **best fumigation practice** to monitor the concentration of fumigant gas inside the enclosure regularly during the exposure period.

#### *When to measure phosphine concentrations*

When using phosphine, it is essential to measure the concentration of gas inside the enclosure:

- six to twenty four (6–24) hours after dispensing **aluminium phosphide** formulations
- two to four (2–4) hours after dispensing **magnesium phosphide** formulations

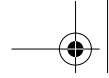

## GUIDE TO FUMIGATION UNDER GAS-PROOF SHEETS

- thirty to sixty (30–60) minutes after dispensing phosphine from cylinders or generators  
This needs to be done to find out:
  - if the gas is evenly distributed (in equilibrium) inside the enclosure
  - when to start timing the exposure period.
- at least once every two days until the end of the exposure period to:
  - make sure gas is not leaking from the enclosure
  - top-up the gas if the concentration falls below a critical level, if this can be done safely (not towards the end of the exposure period)
- at the end of the exposure period to find out if the treatment has been a success or a failure.

### *When to measure methyl bromide concentrations*

When using methyl bromide, it is essential to measure the concentration of gas inside the enclosure at the following times:

- thirty to sixty (30–60) minutes after gassing, to find out:
  - if the correct quantity of gas has been introduced into the enclosure
  - when the gas inside the enclosure is evenly distributed and above a minimum concentration, for example 515 ppm (2 g/m<sup>3</sup>)
  - when to start timing the exposure period
- at least once or twice during the exposure period to:
  - make sure gas is not leaking out of the enclosure
  - **top up the gas if the concentration falls below a critical level, but only if this can be done safely**
- at the end of the exposure period to find out if the treatment has been a success or a failure.

**If you are not monitoring you are not fumigating!**

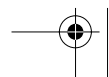

---

**GUIDE TO FUMIGATION UNDER GAS-PROOF SHEETS**

---

**5.4 Gas detector tubes**

Gas detector tubes, and associated pumps, are available from several manufacturers. Each brand has its own equipment and specific set of instructions for use.



Always read and understand the instructions for the pump and tubes you use.

Make sure that you do not contaminate grain or other commodity with the glass tips that are broken off the tubes used to make a test.

It is important to understand the following general points to obtain correct readings with all types of detector tubes.

- Make sure the tube is calibrated for the gas you are working with.
- Make sure it is in-date (or cross-calibrated with an in-date tube).
- Make sure it measures in the range for the planned use (safety or fumigation).
- Always use a pump made by the manufacturer of the tube – because pumps from other manufacturers can give false readings.
- Make sure the pump does not leak.
- Always purge every sampling line before taking a sample of gas.
- Make sure the sampling line is not blocked or broken.
- Always use the correct number of pump strokes for the tube you are using.





## GUIDE TO FUMIGATION UNDER GAS-PROOF SHEETS

### 5.5 Electronic gas-measuring equipment

Electronic instruments to measure concentrations of phosphine and methyl bromide are available from several manufacturers. Each brand has its own equipment and specific set of instructions for use.

However, the results obtained from such instruments are only as reliable and accurate as their calibration and ability to remain calibrated. Because of this the manufacturer's recommendations for calibration must always be followed.



Electronic gas-monitoring instrument that measures both phosphine and methyl bromide at fumigation concentrations.

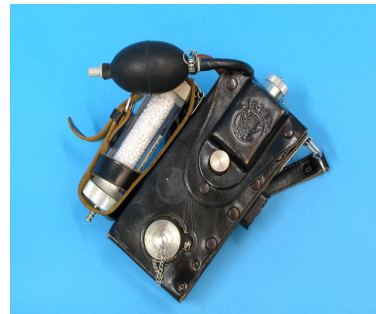

An interferometer used to measure methyl bromide at fumigation concentrations.



Electronic gas-monitoring instrument that measures phosphine at fumigation concentrations.



An electronic instrument that measures phosphine at health and safety levels.

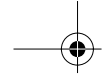

## GUIDE TO FUMIGATION UNDER GAS-PROOF SHEETS

It is **best fumigation practice** to check *at regular intervals* readings obtained by electronic instruments against detector tubes designed for the appropriate range of sensitivity.

If there is any reason to doubt the accuracy of an electronic meter when monitoring is carried out for health and safety purposes, always use detector tubes functional in the appropriate range.

**Carbon dioxide may accumulate within the fumigated enclosure due to insect activity or high-moisture commodity. Also, it may sometimes be used to pressurise cylinders containing methyl bromide, or to assist in distributing the fumigant inside the enclosure. When this is the case, fumigators must be aware that some instruments commonly used to measure methyl bromide concentrations will give incorrect readings due to the high levels of carbon dioxide.**

### *Maintenance of electronic monitoring equipment*

Monitoring equipment requires regular calibration and maintenance to ensure that it operates effectively. This must always be done according to the manufacturer's specifications.

Some instruments have moisture absorbers and carbon dioxide (CO<sub>2</sub>) absorbers fitted to them. The fumigator-in-charge must check and renew absorber or filter materials regularly to ensure that the instrument works properly and accurately.

## 5.6 Using electronic gas detectors

Always read the instructions for use before using an instrument. Some instruments give inaccurate readings when the sensor has either pressure or vacuum applied to it. Some sensors might be damaged when used under pressure or vacuum.

- Always check that the instrument is 'in calibration'.
- Always check the battery.





## GUIDE TO FUMIGATION UNDER GAS-PROOF SHEETS

- Always make sure the gas-sampling line is not blocked or broken.
- Always purge the gas-sampling line before taking a sample and making the reading.
- If there is any doubt about a reading, check it with a detector tube for the gas you are monitoring.

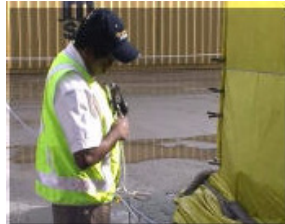

**Many electronic phosphine detectors are cross-sensitive to carbon monoxide. This problem can be solved by making sure that the sensors on such meters are fitted with a carbon monoxide filter.**

### 5.7 Dosimeters

Dosimeters are instruments that measure fumigant gas concentrations over the whole of the exposure period. Such instruments can provide an indication of the likelihood of the success of a fumigation treatment.

Dosimeters are placed inside fumigation enclosures before they are gassed then removed at the end of the exposure period after clearance has been issued.

Dosimeters are available for use with phosphine (as tubes) and methyl bromide (as sachets). Both provide an indication of the total fumigant dosage achieved (as ppm hours or g hours/m<sup>3</sup>) during the exposure period. Because the fumigant is absorbed passively, there is no need for pumps. However, it is essential to ensure that these instruments are properly calibrated when specific end-point concentrations are required.

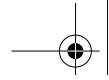

## GUIDE TO FUMIGATION UNDER GAS-PROOF SHEETS

---

In **best fumigation practice**, fumigant concentrations are monitored from the beginning of the exposure period up to, and including, the time when the enclosure has been declared safe to enter and the treated product safe to handle (the active period) in accordance with OH&S, environmental, and other regulatory requirements.

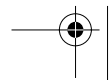
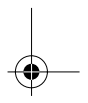
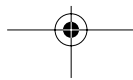
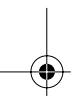
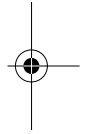

## 6 CHOOSING THE CORRECT FUMIGANT – PHOSPHINE OR METHYL BROMIDE?

The flowchart on the next page details the decision pathway for the choice between phosphine and methyl bromide. It also notes the circumstances under which fumigation is not possible.

### 6.1 Fumigation properties of phosphine and methyl bromide

The properties of phosphine and methyl bromide relevant to their use as fumigants are tabulated below.

Phosphine	Methyl bromide
<b>Self-ignition can occur at concentrations over 17,900 ppm (1.8%, 24.9 g/m<sup>3</sup>)</b>	Flammability classification – non-flammable gas
Penetration - excellent	Penetration – very good
Aeration – very good	Aeration – good
Sorption – slight	<b>Sorption – is a problem with some materials</b>
Skin absorption – negligible	Skin absorption – slight
Chronic poison – no	Chronic poison – <b>yes</b>
Reaction: • as a gas – <b>reacts with copper, gold, silver, brass, 3M copy paper</b>	Reaction: • as a gas – <b>reacts with sulfur compounds</b> • as a liquid – <b>reacts with aluminium and magnesium</b>

## GUIDE TO FUMIGATION UNDER GAS-PROOF SHEETS

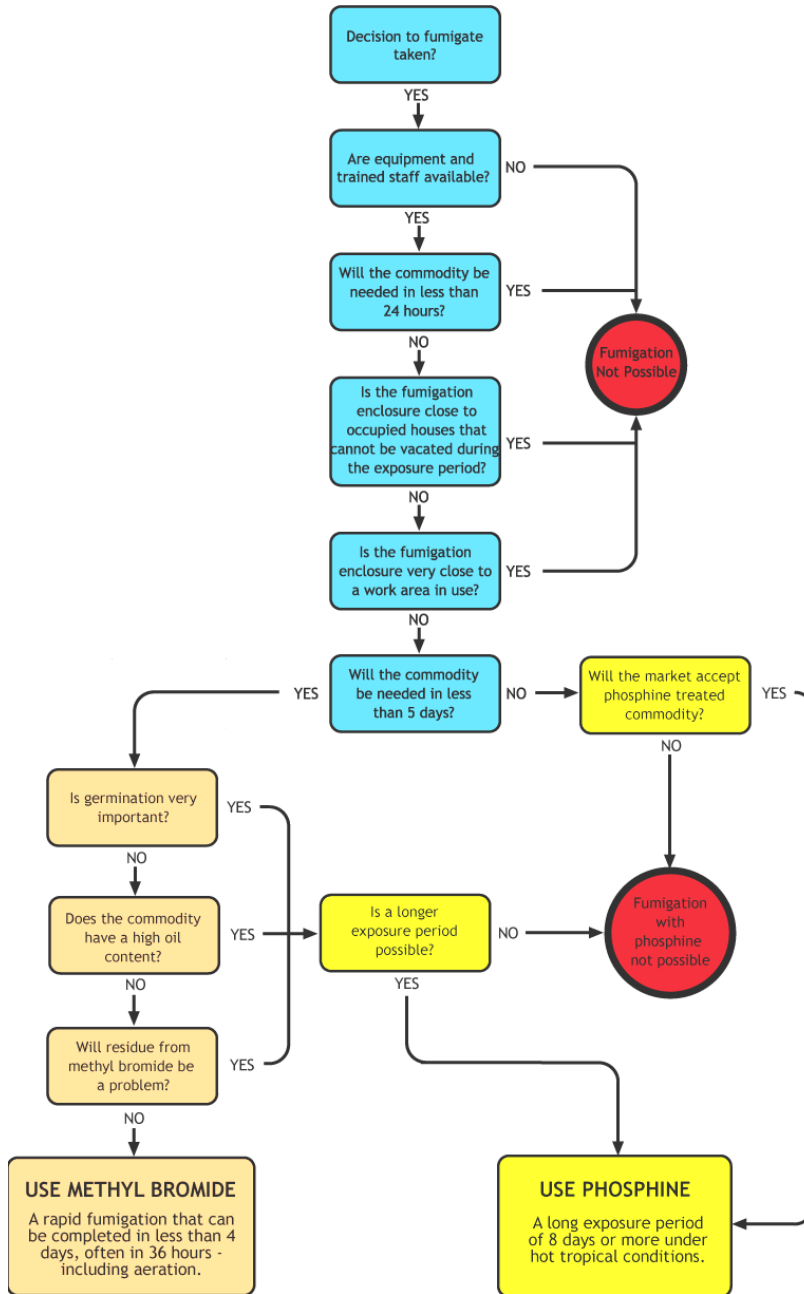

## GUIDE TO FUMIGATION UNDER GAS-PROOF SHEETS

## 6.2 Advantages and disadvantages of phosphine and methyl bromide

Phosphine and methyl bromide each have specific advantages and disadvantages, as tabulated below and on the next page. Contracts or regulations may require that a specific fumigant must be used.

Where this is not the case, it is always advisable to choose the better fumigant for the job.

Phosphine		Methyl bromide	
<i>Advantages</i>	<i>Disadvantages</i>	<i>Advantages</i>	<i>Disadvantages</i>
	Long exposure and airing period required – up to 8 days or more	Rapid kill with 24-hour exposure Broad spectrum	Cumulative poison in humans
	Less effective for use at temperatures below 15°C		Less effective for use at temperatures below 10°C
Not an ozone-depleting substance (environmentally safe)	Long-term availability for use threatened by the development of resistance		A strong ozone-depleting substance Use will be limited to certain critical uses including quarantine and pre-shipment treatments and will be phased-out by: 2005 in industrialised countries; 2015 in developing countries
When properly used, leaves residues of no commercial significance	Repeated application of tablets or pellets into grain may leave residues above the maximum residue limit (MRL)		Leaves residues of commercial importance

**GUIDE TO FUMIGATION UNDER GAS-PROOF SHEETS**

Phosphine		Methyl bromide	
<i>Advantages</i>	<i>Disadvantages</i>	<i>Advantages</i>	<i>Disadvantages</i>
Simple application procedure Existing expertise and training and manuals	Ease of application and misunderstanding of gas loss have led to misuse and over-reliance on a single method	Existing expertise and training and manuals	Application fairly complex Requires electricity
Disperses rapidly inside the enclosure No fans required			Must be vaporised and delivered as a hot gas Requires fans (and electricity) for effective dispersion inside the enclosure
Airs off easily after treatment	Airs off slowly and requires fans (and electricity)		
Relatively easy and safe to transport when in original packaging	Supplied in cylinders that are heavy and relatively difficult to transport		
Cheap	Becoming more expensive because of the international phase-out process		
Not known to affect germination	Germination can be affected – varies with seed and moisture content		





## 7 SHEET FUMIGATION

Sheet fumigation is the most common technique used to fumigate bagged grain and other commodities. It allows fumigation of only the commodities that need to be treated. This may be:

- one bag of grain, or thousands
- one freight container, or several.

Sheet fumigation involves:

- temporarily enclosing whatever has to be fumigated in gas-proof sheets (one or more)
- weighting down the sheets, at floor level, to make a gastight seal on a gastight floor.

Properly done, this technique allows lethal concentrations of fumigant gas to be held inside the fumigation enclosure for the required exposure periods.

### 7.1 Requirements for effective fumigation

Fumigation must not be considered unless all necessary resources are available, so that it can be done safely and successfully. If these resources are not available, then fumigation must not be done.

**Fumigation must not be attempted if:**

- trained fumigators are not available
- the enclosure in which the fumigation is to be carried out cannot be well-sealed to the required standard of gastightness, as will occur, for example, when there are drains under stacks, and stacks built around pillars or columns
- workers and other people cannot be reliably excluded from the enclosure and danger area
- the fumigant cannot be safely aired from the enclosure after the exposure is complete



## GUIDE TO FUMIGATION UNDER GAS-PROOF SHEETS

- the commodity or product to be fumigated is likely to sorb excessive quantities of fumigant
- the temperature or moisture content of the commodity or product to be fumigated is below a threshold value.

### **For reasons of safety, fumigation must not be attempted in structures where:**

- people have to work or live in the same building where fumigation is to be done
- people may be exposed to the fumigant during the aeration period
- a building is closely surrounded by houses where people live.

If none of these conditions apply, and a decision has been made to fumigate, the following resources are essential for a successful fumigation.

### **Trained fumigation staff**

Fumigation is a complicated procedure that requires careful planning and an understanding of the processes involved. Fumigations must be undertaken only by trained and experienced people, who hold recognised, approved and current certification in the country where the fumigation is to be undertaken.



A large building enclosed in gas-proof sheets and fumigated to eradicate an infestation of drywood termites. The enclosure, which took three weeks to build, needed a total of 16 km of 2.5 m wide gas-proof sheeting.

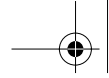

## GUIDE TO FUMIGATION UNDER GAS-PROOF SHEETS

Fumigation teams must be led by a 'fumigator-in-charge'. A high level of supervision is required to ensure:

- the success of a fumigation
- that all the equipment required to do a fumigation is kept in good working order.

In countries where a licence is required to do fumigations, the rule must be 'no licensed fumigator – no fumigation'.



A fumigation team putting a cylinder of methyl bromide on to a platform scale.

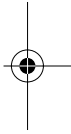

All fumigators must work to the highest professional standards in compliance with local, national and/or international standards and codes of practice to achieve **best fumigation practice**.

### Well-sealed enclosures

Fumigations are carried out in an enclosed space (the fumigation enclosure). It must be possible to seal and make gastight the enclosure in which a fumigation is to be undertaken.



Sheeted fumigation of portable buildings.

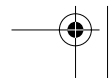
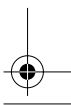
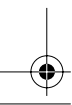

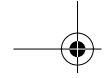

## GUIDE TO FUMIGATION UNDER GAS-PROOF SHEETS

Fumigation enclosures must be well-sealed, so that they can hold an effective concentration of fumigant over the whole of the exposure period.

### Approved fumigant

There must be enough fumigant available before the fumigation starts. The labels on the fumigant must be clear and give full instructions and warning notices in the local language(s).

The fumigant of choice must be:

- registered for use in the country where the fumigation will be done
- acceptable to buyers and end users of the commodity or product to be fumigated.

Choosing the correct fumigant for the treatment is important. Factors that can affect the choice of fumigant include:

- market requirements for the commodity to be fumigated
- the time available to do the fumigation
- the temperature and moisture content of the commodity to be fumigated
- the sorptive capacity of the commodity to be fumigated.

### Materials and equipment

Equipment must include:

- personal-protection equipment (PPE) such as gloves, gas masks and appropriate canisters
- fumigant detection apparatus, available to monitor fumigant concentrations throughout the whole of the exposure period
- gas-sampling tubing and appropriate monitoring equipment
- appropriate fumigant-release equipment. For example:
  - for phosphine – tablet-dispensing equipment, gloves, cylinder gas-dispensing equipment and phosphine gas generators
  - for methyl bromide – gas cylinders, scales, heat exchanger, gas distribution pipes, jets to vaporise the gas.



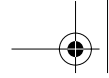

## GUIDE TO FUMIGATION UNDER GAS-PROOF SHEETS

A safe, lockable area must be available to store fumigant and fumigation equipment while the fumigation is being done. This area must be at least 25 m from houses where people live or work.

### 7.2 Planning for fumigations

Contract fumigators generally have little to do with the way things are done in a grain store or warehouse before they are called to do a fumigation. Normally, they are taken to an infested bag-stack and asked to fumigate it.

Fumigators who work for an organisation that stores grain or other commodities that have to be fumigated may be able to influence events leading up to a fumigation. Whatever the circumstances, both contract and 'in-house' fumigators are likely to do a better fumigation if they have sufficient time and are able to plan the treatment. This will maximise the chances of a successful result.

#### The place where the fumigation is to be done

The place where the fumigation is to be done must be:

- **well-ventilated**
- sheltered from rain
- sheltered from wind
- protected from low temperatures.

#### The floor

The floor of any fumigation enclosure must be gastight so that the fumigant gas can be held at the required concentration for the whole of the exposure period.

Concrete and asphalt floors that are not cracked or broken	Soil, sand, broken rock, and paving stones
generally provide a gastight surface for a fumigation enclosure.	are not suitable as a floor for a fumigation enclosure.



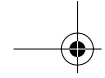

## GUIDE TO FUMIGATION UNDER GAS-PROOF SHEETS

The floor of any site used for sheet fumigation must be:

- flat and free of stones and other sharp objects, so that a gastight seal can be made between the sheets and the surface
- free of cracks and drains or any other openings that will cause fumigant gas to leak out of the fumigation enclosure.

If a concrete floor is:

- cracked or has unsealed expansion joints, these gaps should be cleaned out and sealed with good-quality cement mortar, asphalt, or other sealant to make the floor gastight
- made of poor-quality concrete and is obviously not gastight, it should be coated and sealed with an appropriate paint to make it gastight.

If the floor does not meet these requirements and it is necessary to do a fumigation on such a surface, it must be covered by ground sheets to make it gastight.



A gas-proof sheet is laid on a cracked (and leaky) godown floor to ensure that the enclosure will be gastight.

When ground sheets are used, they must extend one metre beyond the base of the stack built on them, to make sure a gastight seal can be made between them and the fumigation sheets.

The two sheets can be joined and sealed by tightly rolling (one metre) of each sheet together then weighting it down with sand snakes.

Gastightness can be improved if the sheets are rolled around narrow strips of wood or sand snakes and held together with clamps or weights (e.g. sand snakes).

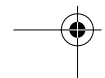

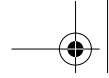

## GUIDE TO FUMIGATION UNDER GAS-PROOF SHEETS

### Bag-stacks

Check and make sure there is enough room to work on the top of and all around the stack.

Stacks must be separated from each other and the walls of the warehouse by at least one metre. Gangways in the warehouse must be at least two metres wide to allow fumigation sheets to be unrolled.

If a stack has been built:

- with bags too close to walls or posts
- **around posts or pillars**

do not start the fumigation until the stack is rebuilt so that it can be enclosed safely and effectively.

Make sure the area around the stack is swept clean so that a good floor seal can be achieved when the sheets are weighted to the floor.



Bag-stacks must be well built so that there is no possibility of them collapsing during fumigation operations.

Rectangular stacks are preferred because:

- fewer sheets are needed to enclose them
- less fumigant is needed because they do not contain as much free air as irregularly shaped stacks.

However, even though it may be more difficult to enclose irregularly shaped stacks, this has no influence on the effectiveness of the selected fumigant gas.



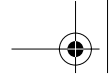

## GUIDE TO FUMIGATION UNDER GAS-PROOF SHEETS

In **best fumigation practice**, well-planned fumigations mean that it must not be necessary to:

- do fumigations at short notice
- do fumigations on floors that are not gastight or are otherwise unsuitable for fumigation
- do fumigations where there is not enough space to safely and properly enclose the stacks
- use exposure periods shorter than those recommended
- do fumigations where people have to work close to stacks under fumigation.

### Pallets

Stacks are often built on timber dunnage (pallets). If a floor sheet is used, it is essential to examine the underside of each piece of dunnage before it is placed on the floor sheet. Any nails or other objects likely to damage the floor sheet must be removed.

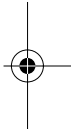

## 7.3 People needed to do a fumigation

### Minimum number of persons

Regardless of how small the dosage or how small the fumigation enclosure, there must always be at least two people present at a fumigation at the times when:

- gas is put into a fumigation enclosure
- gas is removed from a fumigation enclosure during aeration.

One of these two people must always be designated the 'fumigator-in-charge' and be properly qualified.

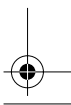
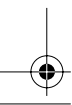



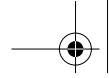

## GUIDE TO FUMIGATION UNDER GAS-PROOF SHEETS

### Emergencies

In emergencies, where a person becomes disabled in a fumigation enclosure or the risk area, the rescue team must include one person who does not enter the enclosure or risk area.

This person has one job only – to go for more help if the rescuers also become disabled – nothing else.

In **best fumigation practice**, the response to emergency situations with fumigants is made using emergency procedures in accordance with environmental, OH&S and other regulatory requirements.

### Qualifications of fumigation staff

At least one person working at a fumigation must be a trained and experienced fumigator, holding a recognised, approved and current certification (if necessary or available) in the country where the fumigation is being done.

This person must be appointed fumigator-in-charge and given responsibility for doing the fumigation safely and effectively.

The fumigator-in-charge must be present at all times during the active stages of the fumigation.

### Fumigator-in-charge

For a treatment to be successful, it is essential that the fumigator-in-charge:

- understands the requirements for fumigation with either phosphine or methyl bromide under gas-proof sheets
- can carry out all tests needed to ensure the fumigation will be successful
- can recognise when a fumigation is successful.

This means that the fumigator-in-charge:

- understands what is needed to do a successful fumigation with phosphine or methyl bromide
- is aware of the dangers associated with the use of phosphine or methyl bromide

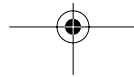
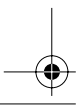
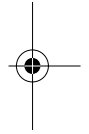
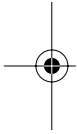

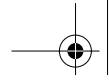

## GUIDE TO FUMIGATION UNDER GAS-PROOF SHEETS

---

- can recognise a fumigation failure
- can measure the concentration of phosphine or methyl bromide inside and outside a fumigation enclosure.

Before the fumigation starts, the fumigator-in-charge is responsible for:

- planning how the treatment will be done, including the aeration after treatment
- explaining the fumigation plan to
  - assistant fumigators
  - the owners of the commodity
  - any other parties involved in the fumigation
- obtaining all materials and equipment needed to do the fumigation
- telling any government agencies involved when and where the fumigation will be done
- marking the danger area around the site of the fumigation
- putting up warning notices to show people where the danger area is before starting the fumigation
- making sure that nobody except the fumigators is in the danger area
- monitoring gas concentrations during the exposure and ventilation period.

At the end of the exposure period, the fumigator-in-charge is responsible for:

- certifying, after aeration is complete and the gas concentration is at or below the TLV, that the danger area is safe to enter
- supervising the collection and safe disposal of any spent fumigant-generating products and contaminated packaging materials
- removing all warning signs and barriers
- informing any government agencies involved that the fumigation has been completed.

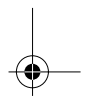
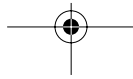
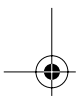
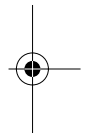
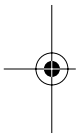



## GUIDE TO FUMIGATION UNDER GAS-PROOF SHEETS

### 7.4 The danger (exclusion, hazard or risk) area

Wherever a fumigation is done, there is an area surrounding the fumigation enclosure into which a fumigant gas may escape in concentrations that:

- are dangerous to the people doing the fumigation
- may harm people living and working in the area around the fumigation treatment area
- may harm the environment.

**This area is called the *danger (exclusion, hazard or risk) area*.**

It is essential to ensure that people who are not directly involved in the fumigation process do not enter this area. This must be done by marking the boundary of the *danger area* in accordance with national or local government regulations.

Where no such regulations exist, the following definition may be used as a guide for setting up the danger area:

- The *danger area* must include an area that extends for a distance of at least 6 metres from the edges of any fumigation enclosure.

#### Marking out the danger area

Warning notices must be placed around the outer limits of the danger area. These notices must indicate:

- the name of the fumigant (e.g. phosphine or methyl bromide)
- the name and address of the fumigator-in-charge
- emergency telephone numbers (including those of the fumigator-in-charge, and the nearest hospital, fire brigade, and police station).

People must not enter the danger area without the permission of the fumigator-in-charge.

Special care must be taken in buildings or rooms with walls common to an area that is to be fumigated. Leakage into such spaces can often occur. Because of this, they must be included in the risk area.

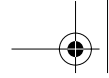

## GUIDE TO FUMIGATION UNDER GAS-PROOF SHEETS

**The danger area must be clearly marked in accordance with national or local government regulations.**

This is done to warn people not involved in the fumigation treatment not to enter the area.

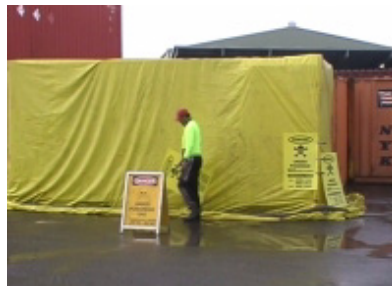

Where necessary, the fumigator-in-charge must take possession of the keys to any doors in the fumigation and danger areas.

The fumigator-in-charge must, immediately before gassing an enclosure, fasten a warning notice to all doors and other means of access to the fumigation area.

The warning notices must be made and display a text in accordance with national or local government regulations. They must also contain a warning symbol appropriate to the country/culture concerned.

Where no such regulations exist it is suggested that the text at the top of the next page (with appropriate danger warning symbol) may be used as a guide.

The notices should have a white background, and the printing must be in capital letters not less than 10 cm (3 inches) high, in a colour that stands out from the background.

All warning notices must be suitably illuminated at night.

Wherever possible, arrangements must be made to lock or bar all access points to the danger area.



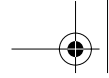

## GUIDE TO FUMIGATION UNDER GAS-PROOF SHEETS

<p style="text-align: center;"><b>Danger symbol</b></p> <p style="text-align: center;"><b>DANGER – KEEP OUT</b></p> <p style="text-align: center;"><b>POISON GAS</b></p> <p style="text-align: center;"><b>FUMIGATION WITH [INSERT NAME OF GAS]</b></p> <p style="text-align: center;">Name of fumigator-in-charge Contact telephone number(s) for fumigator-in-charge</p> <p style="text-align: center;">Name of fumigation company Contact address of fumigation company</p> <p style="text-align: center;">Telephone number of nearest hospital Telephone number of nearest fire brigade station Telephone number of nearest police station</p>
--

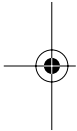

Two watchmen must be present at the start of the fumigation and must remain on-site, but outside the danger area, throughout the treatment, to make sure unauthorised and unprotected persons do not enter the risk area.

In **best fumigation practice**, appropriate warning signs and barriers are put in place as required to maximise public health and safety in accordance with OH&S, environmental and other regulatory requirements.

### 7.5 Monitoring fumigant concentrations

During any fumigation, some gas will leak out of the enclosure being fumigated. The main reasons for leakage include:

- the condition of the fumigation sheet(s) (whether new or repeatedly used, or punctured)
- how well the sheets are sealed to the floor

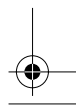
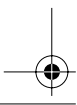

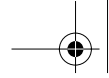

## GUIDE TO FUMIGATION UNDER GAS-PROOF SHEETS

---

- the gastightness of the floor
- whether wind is blowing over and around the enclosure.

It is not possible to accurately predict how much gas will leak or where it will leak from. The only way to find out if gas is leaking from an enclosure is by monitoring.

Monitoring is the process of measuring the concentration of fumigant gas inside a fumigation enclosure and in the area surrounding the enclosure.

Monitoring gas concentrations in the area surrounding a fumigation enclosure allows the fumigator to:

- ensure that fumigant concentrations in the workspace are safe to work in and do not exceed the **threshold limit value (TLV)**
- ensure that fumigant concentrations in the fumigated commodity do not exceed the TLV at the end of the exposure period when it is *aerated* to allow *desorption* of the fumigant gas (so that the commodity can be safely handled).

Monitoring gas concentrations inside a fumigation enclosure allows the fumigator to:

- find out if the correct quantity of gas has been introduced into the fumigation enclosure
- find out when the gas inside the fumigation enclosure is evenly distributed and when to start timing the exposure period after an effective concentration has been reached
- find out if the fumigant is leaking from the enclosure
- make dosage corrections to ensure that the fumigation treatment will be successful
- find out if the target endpoint gas concentration has been reached.

Monitoring is a key component of **best fumigation practice**.

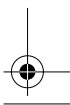
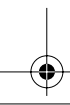
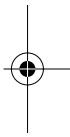
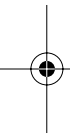



## GUIDE TO FUMIGATION UNDER GAS-PROOF SHEETS

### 7.6 Gas-sampling tubing

To monitor the concentration of fumigant gas inside enclosures it is necessary to pump some of the gas out of the enclosure. Flexible plastic tubing is usually used for this purpose.

It is preferable to use tubing with a small internal diameter (e.g. 2–5 mm internal). This reduces the time required to remove all the air in the tubing before a gas sample can be pumped out of the enclosure. The latter process is called purging.

In practice, crushproof nylon tubing (hydraulic hose) has been found to be effective for this purpose. However, care must be taken at all times to make sure that:

- the tubing is not kinked or blocked
- the gas/air can flow freely through the tubing
- the tubing is properly purged so that the gas concentration being measured is equal to that **inside** the fumigation enclosure.

#### Position of the gas-sampling tubing

Where practical and possible there should be at least three gas-sampling tubes inside the fumigation enclosure, one in each of the following positions:

- at floor level – at the front of the enclosure
- at the top – at the back of the enclosure
- in the middle of the product being fumigated.

See the photographs on the next page.

Outside the enclosure, it is essential that each gas-sampling tube can be identified. This can be done by attaching labels to the tubing or by using tubing of different colours.

Gas-sampling tubing must **not** be placed near:

- a fumigant gas supply pipe
- phosphine-generating tablets or pellets.



## GUIDE TO FUMIGATION UNDER GAS-PROOF SHEETS

Inserting gas-sampling lines at the top, middle and bottom of a bag-stack to be fumigated in a sheeted container.



**All tubing for gas sampling must be long enough for the samples to be taken OUTSIDE the danger area and without the need for respiratory protection.**



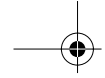

## GUIDE TO FUMIGATION UNDER GAS-PROOF SHEETS

### 7.7 Specifications for fumigation sheets

Fumigation sheets (gas-proof sheets or tarpaulins) are nowadays almost always made from plastic sheets. Fumigation sheets must:

- be resistant to ultraviolet light (3% UV-stabilised material is satisfactory)
- be resistant to tearing (at least 10 kg along length and width)
- remain stable at temperatures up to 80°C
- be impermeable to phosphine (*gas loss must be less than 1 mg/day/m<sup>2</sup>*)
- be impermeable to methyl bromide (*gas loss must be less than 0.02 g/day/m<sup>2</sup>*)
- be light enough to be carried (*an average weight is 200–250 g/m<sup>2</sup>*).

There is an unavoidable maximum size for a fumigation sheet that depends on its weight. It must be light enough to be handled easily by a fumigation team. Generally, a sheet of 18 × 12 metres provides a convenient standard size.

No single plastic material meets all the above requirements, so the final choice will depend on one or more of the following factors:

- sheet material locally available
- cost
- intended use (e.g. at just one or several sites)
- permeability to fumigants to be used
- weight per square metre (*g/m<sup>2</sup>*).
- strength of the material (e.g. resistance to tearing)
- handling characteristics (e.g. resistance to abrasion)
- resistance to UV light and heat
- resistance to damage by liquid methyl bromide (if the sheets are to be used for methyl bromide fumigations).

Materials that are suitable for use as fumigation sheets include:

- unsupported PVC
- woven polythene
- PVC laminate
- PVC on a nylon or terylene scrim
- multi-layer thin-film laminates.

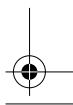
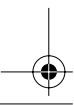
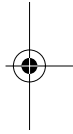

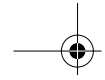

## GUIDE TO FUMIGATION UNDER GAS-PROOF SHEETS

Materials that are **not suitable** for use as fumigation sheets include:

- pool liners or annealed polypropylene sheets
- thinly coated, widely woven materials

Plastic sheeting is generally specified by the:

- thickness of the sheet, commonly expressed in millimetres (mm) or microns (1 micron = one thousandth of a mm), often referred to in the trade as 'mil'
- weight of the sheet, usually expressed as grams per square metre ( $g/m^2$ ).

The choice of material will also be influenced by the purpose for which a sheet will be used. For example:

- new 125 micron polythene sheet is good enough to use **once only** (NB: LDPE 125 micron sheeting is inadequate for methyl bromide fumigation under warm conditions)
- fumigation sheets to be used only within a single storage complex do not need to be as strong as those which have to be transported from one storage site to another (unsupported 250 micron polythene or PVC can be quite satisfactory for single-site use).

Sheets can be made to any required size by joining panels with high-frequency welding. To prevent finished sheets from tearing, all the edges should be reinforced with a seam.

**Do not use sheets that have been sewn or stitched together!**

### Care of fumigation sheets

Fumigation sheets must be handled with care to ensure that they do not get torn, holed or damaged in any way that will reduce their gastightness.

- Fumigation sheets must not be dragged over rough ground, pallets or floors – always carry them.
- Sheets must never be pulled with force when enclosing stacks – this will cause rips and tears that are difficult to repair.

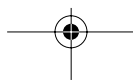



## GUIDE TO FUMIGATION UNDER GAS-PROOF SHEETS

- Always avoid walking on fumigation sheets – because they will be punctured if there are small stones on floors or the ground.
- Good storage and careful handling prevents damage and extends the life of fumigation sheets. They must be folded together neatly and stored on pallets. Fumigation sheets that are carelessly thrown in a heap in a corner will be damaged by rodents.
- Inspect fumigation sheets regularly. Any holes or tears must be repaired immediately. Small tears can be sealed using insulating tape on both sides of the sheet, and larger ones by sticking a piece of sheet material over them. A special adhesive may be required for this (e.g. PVC solvent glue).
- Always inspect new fumigation sheets before use, to ensure they have not been damaged during transport; e.g. by use of hooks.

### 7.8 Products in impervious wrappings, surfaces and coatings

Sometimes products may be:

- covered with, or packaged in, plastic wrapping or laminated plastic films
- packed in aluminium foil, or tarred or waxed paper
- painted
- coated with lacquer.



Shrink-wrapping on palletised goods being cut as the goods are loaded into a container before fumigation, to allow penetration of fumigant.



## GUIDE TO FUMIGATION UNDER GAS-PROOF SHEETS

All of these materials are known to slow the rate of penetration of fumigant gases. This can be critical in some treatments; for example, those undertaken for quarantine purposes.

To make sure that fumigant gases can penetrate into products packaged in these ways, fumigators must open or cut plastic wrapping, laminated plastic films, aluminium foil, and tarred or waxed paper. This will also allow the gas to escape when the commodity is aired after the exposure period.

**Fumigators must inform their customers that packs of products in impervious wrappings have to be opened before fumigation.**

Some paints, lacquers and laminates may slow the rate of, or even prevent, penetration of fumigant gases. There is a risk of fumigation failure when materials treated in this way are fumigated. Fumigators must therefore inform their customers that a treatment of such items may not be successful, and that an alternative treatment such as vacuum fumigation may be available.

### 7.9 Methods for safe storage and handling of gas cylinders

**Cylinders of compressed gas can be very dangerous!**

In the course of their work, fumigators have to handle cylinders that contain compressed gases, including phosphine, methyl bromide, air, and carbon dioxide.

Fumigators must understand exactly what harm these cylinders can cause, and how to handle them properly to avoid the danger to life and property that can result when cylinders are not handled correctly.

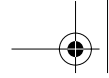

## GUIDE TO FUMIGATION UNDER GAS-PROOF SHEETS

### **What must you know about cylinders of compressed fumigant gas?**

- They contain poisonous gases under very high pressure.
- All cylinders carry a label that tells you the name of the gas they contain.
- The colour of the cylinder *does not* tell you what gas it contains.
- Cylinders are only one piece of a two-part system – without a correct regulator or manifold they cannot function correctly.

### **When using cylinders of compressed gas you must remember the following points**

- Do not remove the cylinder cap until the cylinder has been secured.
- If the cap is stuck or jammed, return the cylinder to the supplier.
- Know how to safely install and remove them from your gassing system.
- Make sure they are properly secured when you use them and when you store them.
- When you use them, open their valves slowly.
- Always close their valves when you have finished using them.
- Know the dangers of the gas or gases in the cylinder – read the material safety data sheets (MSDSs), and follow proper procedures when using the cylinders.

### **Always move and store cylinders correctly**

- Keep cylinders cool. The pressure inside the cylinder will rise if it is heated by, for example, being put near a burner, heater or oven, or left in full sunlight.
- Separate and store full and empty cylinders apart, to avoid confusion and interruptions to fumigation procedure.
- Keep cylinders upright at all times when using, transporting or storing them.
- Do not drop cylinders or subject them to severe physical forces.
- Protect cylinders from being knocked over.
- Protect cylinders stored in the open against extremes of weather.
- Protect cylinders from conditions likely to cause corrosion (rust).

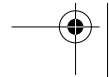
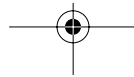
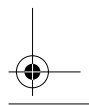
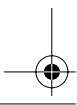
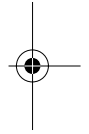
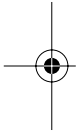

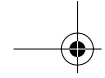

## GUIDE TO FUMIGATION UNDER GAS-PROOF SHEETS

### When things go wrong

You must understand that, if the valve or regulator of a cylinder of compressed gas snaps off, all the energy inside the cylinder is released through a hole no wider than a pencil, and the cylinder will:

- jet away faster than any motor vehicle
- smash through brick walls
- spin, ricochet, crash, and smash through anything in its way.

### To be in control you must always remember:

- to secure cylinders of compressed gas
- to 'cap' cylinders of compressed gas, when they are not in use
- to follow recommended safety procedures.

### To be prepared for emergencies you must:

- make sure the gas supply can be turned off quickly in an emergency
- keep appropriate emergency equipment close at hand
- make sure that the following emergency telephone numbers are readily available
  - fire brigade
  - doctor
  - ambulance.

**Always handle cylinders of compressed gas very carefully — they can be very dangerous!**

In **best fumigation practice**, the whole fumigation process is conducted using safe operating practices in accordance with OH&S, environmental, other regulatory requirements, and equipment and chemical manufacturers' specifications/instructions.

## 7.10 Enclosing (sheeting) a stack

### Calculating the size of sheeting required

The area of sheet required to cover a stack is calculated as follows:





## GUIDE TO FUMIGATION UNDER GAS-PROOF SHEETS

- Measure the height, width and length of the stack.
- To get the total width of sheet required, add height + width + height + 2 metres.
- To get the total length of sheet required, add height + length + height + 2 metres.

The extra 2 metres is required to provide one metre around the edges of the stack so the sheet can be weighted down to provide a well-sealed enclosure.

A single sheet should be used to enclose a stack whenever possible, because this reduces the chance of gas loss during the exposure period.



Rolled fumigation sheets are placed at the bases of stacks before lifting them to the top of the stack, making sure there is enough sheeting at floor level to make a gastight seal.

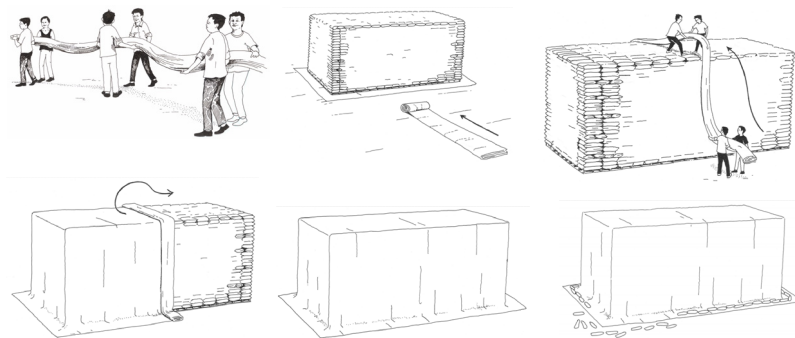

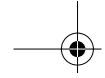

## GUIDE TO FUMIGATION UNDER GAS-PROOF SHEETS

A well-folded sheet can be correctly orientated on top of the stack and then opened out to cover it with the minimum of manual effort. In **best fumigation practice**, sheets must always be lifted and carried. They must never be dragged across the floor because this can damage them and reduce their gas-proof properties.

To keep fumigant leakage to a minimum, sheets must be carefully sealed to the floor. This is done by weighting them so that they are in close contact with the floor. **Sand snakes** or water snakes (also called flumes) provide the most effective way of doing this.

In **best fumigation practice**, sand snakes are laid in two rows around the fumigation enclosure.

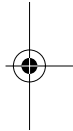

### Maintaining fumigation sheets

After the fumigation sheet(s) have been put in position on a stack – *and before any fumigant is introduced into the enclosure* – they must always be inspected.

Any holes and tears found must be repaired immediately. Temporary repairs can be made using wide, adhesive, plastic tapes (e.g. duct tape). However, fumigators must be aware that such materials will very soon lift off. Wherever possible, a more permanent repair should be made.

This process of inspection and repairing defects must be repeated at the end of every fumigation exposure, when the sheets are laid out flat on the floor ready to be folded.

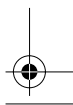
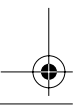



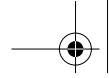

## GUIDE TO FUMIGATION UNDER GAS-PROOF SHEETS

In **best fumigation practice**, fumigation sheets are inspected regularly; for example, at monthly intervals, or while they are in use.

A good way to do this is to suspend the sheet over a long pipe in a store and inspect it against a light (e.g. an open doorway). This allows any holes to be detected very easily by the daylight showing through them.

All holes, rips and tears must be repaired *permanently*. Note that patches applied to PVC sheets using rubber-based glues tend to come loose very rapidly – especially when exposed to sunlight.

Permanent repairs can be made using glues that are compatible with the sheets. For example, PVC sheets are best repaired with patches made from PVC sheeting and using PVC solvent glues. Other, non-PVC-based glues that provide permanent repairs are also available.

Fumigators should ask their fumigation sheet supplier/manufacturer about glues that can be used to provide effective and long-lasting patches.

Patches made with adhesive tapes NEVER provide a permanent seal and tend to peel off very rapidly, especially when exposed to heat, which softens the glues used in tapes. All such patches should be replaced with a permanent patch every time a sheet is inspected.

Never sew patches onto fumigation sheets. The needle holes allow gas to leak and weaken the sheet, and may cause large rips and tears.

### Storing fumigation sheets

For ease of handling, fumigation sheets should be folded as illustrated on the next page.

Fumigation sheets must always be kept in a rodent-proof store. This is essential because rats and mice sometimes nest in folded fumigation sheets, and can cause considerable damage by their chewing.

Where fumigation sheets are not stored in this way and not used or inspected regularly, it is not unusual to find them damaged beyond repair.

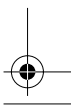
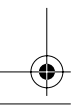
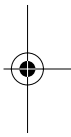

## GUIDE TO FUMIGATION UNDER GAS-PROOF SHEETS

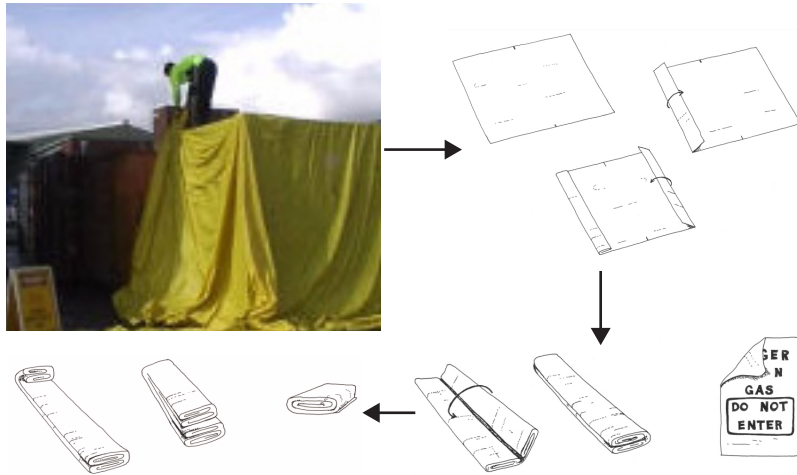

### Joining gas-proof sheets to cover large stacks

Frequently, more than one sheet is required to cover a stack. When this happens, the sheets must be joined. The seams made where sheets are joined are normally the weakest point in the enclosure – where gas leakage is most likely to occur. Because of this, the joins should, wherever possible, be made vertically – that is, from the floor up to the top of the enclosure then down to the floor on the other side of the stack.

Horizontal joins – those that go around the sides of a stack/enclosure – will pull apart unless they are made very carefully. Normally, there is no need to join sheets in this way when fumigating bag-stacks of grain and other commodities.

Whenever it is necessary to join sheets, the joins must be made so that they (i) do not break apart and (ii) provide a gastight seal.

This is done by:

- pulling the edge of the first sheet back over itself for 1 metre
- positioning the second sheet on the stack so that its edge lies on the edge of the folded-back first sheet
- next, rolling the overlapped area as tightly as possible. To help make a good gastight seal, the sheets may be rolled around thin



## GUIDE TO FUMIGATION UNDER GAS-PROOF SHEETS

narrow strips of wood. These may be made by cutting sheets of plywood into strips 4–5 cm wide.

- after they have been rolled, the sheets are held firmly on the strips of wood using clamps or weights to stop the sheets unrolling.



Sheets joined by rolling, held together by spring clips

Sand snakes can be used to weight down rolled sheets on top of a stack, but spring clamps are required on the sides of a stack.

Clamps should be attached to the rolled sheets at not more than 20 cm intervals.

At floor level, the rolled sheets must be flattened so that they can be properly weighted down by sand snakes to make a good seal with the floor.

On very large stacks, three or more sheets may have to be joined together to make an enclosure. Where two wide sheets and one narrow sheet are available, always place the narrow sheet in the middle of the stack to evenly distribute the pull against the seams.

If a narrow sheet is not available in the size needed, it is better to create one with a folded sheet than to have surplus sheet material on the top or at the bottom. This is done by:

- taking the larger sheet and folding it in half
- measuring the gap to be filled and adding one metre for sealing on each side

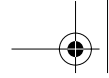

### GUIDE TO FUMIGATION UNDER GAS-PROOF SHEETS

- then dividing by two, the gap plus two metres (because the sheet is doubled) and marking this distance in from the unfolded edges and rolling the folded edge up to this point
- hold this rolled edge firmly with clamps, or other sand snakes then unfold
- now a sheet of the exact width needed will be available.

If many sheets are needed, it is better to stagger (arrange in zigzag order) the horizontal and vertical joins to give them maximum strength.

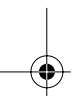
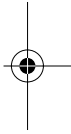
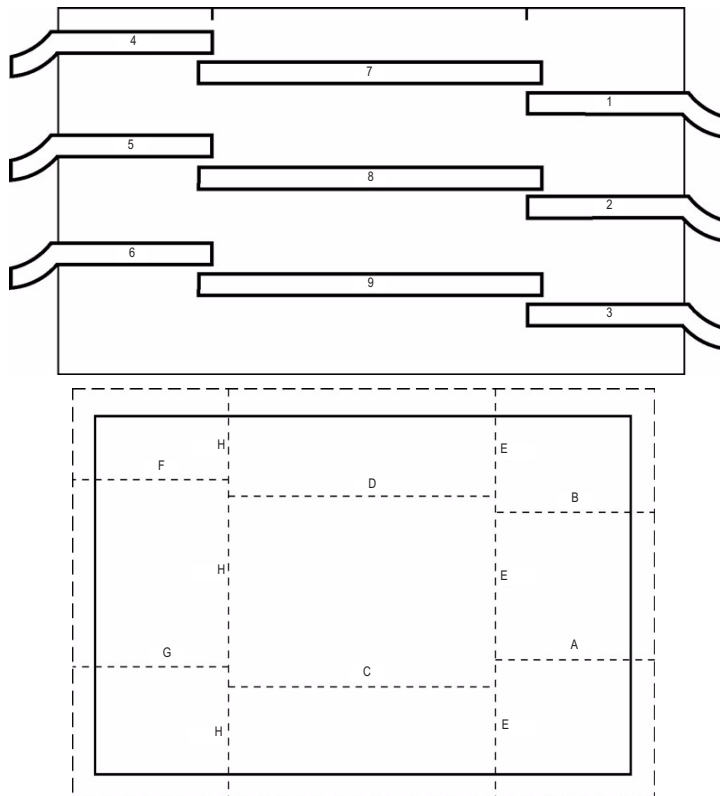



## GUIDE TO FUMIGATION UNDER GAS-PROOF SHEETS

**7.11 Metric/imperial conversions for fumigators****Temperature**

°C (degrees Celsius)	°F (degrees Fahrenheit)
10	50
15	59
20	68
25	77
30	86

**Distance/length**

m (metres)	ft (feet)
1.0	3 ft 3.372 inches
0.305	1 foot (= 12 inches)

**Volume/space**

m <sup>3</sup> (cubic metres)	ft <sup>3</sup> (cubic feet)
28.31	1000
1.0	35.31
0.028	1.0

**Mass/weight**

kg (kilograms)	lb (pounds)
1.0	2.205 lb or 2 lb 3.3 ounces
0.454	1.0



## GUIDE TO FUMIGATION UNDER GAS-PROOF SHEETS

**Dose in grams (g) per cubic metre (m<sup>3</sup>) = ounces (oz) per 1000 cubic feet (ft<sup>3</sup>) = mg per L (approx.).**

**Thus, 1 lb/1000 ft<sup>3</sup> = 16 g/m<sup>3</sup>.**

**Throughout this document the symbol g/m<sup>3</sup> means grams per cubic metre.**

### 7.12 Volume of the fumigation enclosure

The volume of the fumigation enclosure needs to be calculated accurately, so that the correct dosage to be applied can be determined.

For the purposes of sheet fumigation, the volume of an enclosure is all of the space enclosed under the gas-proof sheets.

The volume of the enclosure is calculated by multiplying the height (H) by the width (W) by the length (L):

**Volume of enclosure = height × width × length.**

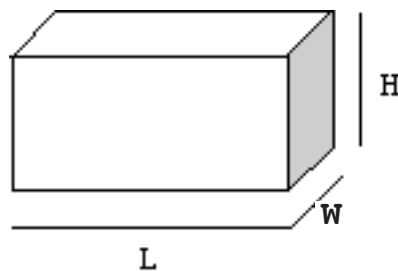

**Volume measurements for calculating the required dosage of fumigant should be made to the nearest cubic metre.**

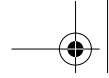

## GUIDE TO FUMIGATION UNDER GAS-PROOF SHEETS

### 7.13 Sealing fumigation sheets to the floor

The best way to seal sheets to the floor of the fumigation enclosure is to put some form of continuous weight on top of the edge of the gas-proof sheet that is lying on the floor of the enclosure. This must be done so that the sheet is weighted firmly onto the floor leaving no gaps through which gas can leak.

A variety of weights has been used for this purpose including:

- sand snakes
- chains
- timber
- rolled bags
- loose sand or mud.

#### Sand snakes

Sand snakes are most commonly used to seal sheets to the floor of the enclosure. They are simply long tubular sand bags and may be made using a number of different materials. Sand snakes are best for sealing because they are:

- flexible and can apply pressure on floors that are not completely flat
- soft, so they do not damage fumigation sheets
- applying a lot of weight to a small area
- easy to make
- reusable.

Sand snakes can be made from various materials.

- Plastic tubing of appropriate diameter can be cut into suitable lengths, which are then filled with dry sand and their ends knotted, glued or heat-welded. This is the easiest way to make sand snakes.
- Lengths of old canvas fire hose filled with sand provide the longest-lasting sand snakes.
- Old fumigation sheets can be cut into pieces of suitable size and stitched together into snakes.
- Jute or polypropylene bags, or tough, canvas-type material can be cut and stitched to an appropriate size.

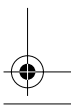
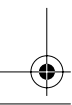
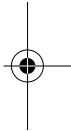

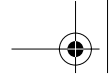

## GUIDE TO FUMIGATION UNDER GAS-PROOF SHEETS

It is important that sand snakes be made so they:

- are not too long or too heavy
- can be easily carried by fumigation staff.

However, sand snakes must also be heavy enough to weight the sheet firmly down onto the floor. This is particularly important where floors are not completely flat. Ideally, sand snakes must have a diameter of 10–15 cm, with 10 cm being the minimum size.

A sand snake must not be filled to more than 85–90% of its capacity. It is important to fill sand snakes with dry sand.

A correctly filled sand snake can be turned around a right-angle corner with an even distribution of sand along the full length of the sand-snake.

- If it is over-filled, it is impossible to turn.
- If it is under-filled, it is very easy to turn because there is not enough sand in it.

### Chains

Chains are sometimes used to seal fumigation sheets to the floor. They have two disadvantages:

- They do not provide as good a seal as sand snakes because, due to the 'gap' at every link in the chain, they do not provide continuous and even weight on the sheet.
- Every time a chain is dropped onto a sheet it makes pin holes that can be the cause of considerable gas loss.

**Used with considerable care, and with new sheets, chains can provide enough weight to make a good seal. However, use of chains is *not recommended in best fumigation practice.***

### Timber

Lengths of timber must not be used to seal fumigation sheets to the floor. This is because timber is inflexible and often warped. This







## GUIDE TO FUMIGATION UNDER GAS-PROOF SHEETS

means that it cannot press a sheet down onto a flat floor and allows gas to leak from any enclosure 'sealed' in this manner. On uneven floors, gas loss is likely to be much greater.

**Use of timber to seal sheets to the floor is *not* recommended in *best fumigation practice*.**

### Rolled bags

Empty jute (gunny) bags that have been rolled and sewn together are sometimes used to seal fumigation sheets to the floor of the enclosure.

Bags rolled in this way are not heavy enough to press a sheet down onto the floor and will allow fumigant gas to escape from the enclosure.

In addition, empty bags provide food and shelter for small populations of insects that can be the cause of rapid reinfestation of the fumigated product.



**The use of rolled empty bags or timber to seal sheets to the floor is *not recommended* in *best fumigation practice*.**



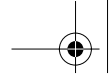

## GUIDE TO FUMIGATION UNDER GAS-PROOF SHEETS

### Loose sand and mud

Loose sand and mud are commonly used to seal fumigation sheets to the floor. When used properly, these materials can provide a very effective seal for a fumigation enclosure.

Both loose sand and mud tend to spread when poured onto flat surfaces. Because of this, there is a tendency not to put enough of these materials onto the sheets to weight them down properly to make an effective seal. This effect is worst where sheets are folded.

However, when enough sand or mud is used to seal sheets to the floor of the fumigation enclosure, a very good seal can be achieved.

The disadvantages of these materials are:

- the time required to remove them from the fumigation sheets and the warehouse at the end of the exposure period
- the possibility of the sheet(s) being punctured by sand trapped inside them when they are folded.
- mud sealing is totally ineffective for phosphine fumigation requiring 7 or more days exposure. The mud dries out and cracks, allowing the fumigant to leak out.

### Sealing fumigation sheets to the floor

To seal the sheet(s) to the floor:

- always use **two rows of sand snakes** laid closely side by side
- put them right up against the side of the bag-stack or whatever will be fumigated





## GUIDE TO FUMIGATION UNDER GAS-PROOF SHEETS

- lay the sand snakes like two courses of bricks so that one row covers the gaps in the other row
- at every corner make sure at least one sand snake goes around the corner.



A single row of sand snakes may be used only when the sand snakes are 15–20 cm wide. Such sand snakes should provide a floor contact at least 10 cm wide.

**If the fumigation is done with phosphine**, and the tablets or pellets have to be placed on the floor along the sides of the stack because they cannot be put under a stack, make sure not to spill them out of their trays when putting sand snakes along the sides of the stack.

**If the fumigation is done with methyl bromide**, it is important to remember to properly seal the sheet over the gas introduction (shooting) pipe. This is done by placing a sand snake on either side of the pipe and pushing them up against the sand snakes laid around the enclosure.

**Never use bags filled with grain or other commodities for sealing purposes because they may be infested and provide a starting point for reinfestation.**



## GUIDE TO FUMIGATION UNDER GAS-PROOF SHEETS

### 7.14 Container fumigation



#### **Fumigation of loaded freight containers**

Freight containers may be new, or appear to be in good condition, but this does not guarantee they are gastight.

**Fumigators must not assume that all freight containers are well sealed and gastight. THEY ARE NOT!**

Unless it can be shown they are well-sealed, all freight containers must be fumigated under gas-proof sheets.

Therefore, all standard procedures for fumigating bag-stacks under gas-proof sheets with either phosphine or methyl bromide must be followed when fumigating loaded containers.

#### **Pressure testing containers to find out if they are well-sealed**

One way to find out if a container is sufficiently well-sealed to be fumigated without enclosing it under gas-proof sheets, is to pressure-test it.

Because air expands when it is heated, pressure-testing should preferably be done early in the morning when it is still cool, or with the container shaded from direct sunlight.

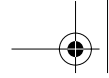

## GUIDE TO FUMIGATION UNDER GAS-PROOF SHEETS

### The pressure-test procedure

Before pressure testing the ventilators must be closed and sealed.

The gastightness of a container can be measured by the time taken for a pressure of 200 pascals (inside the container) to fall to 100 pascals (Pa).

This is done by pressurising the container with compressed air. When the pressure reaches 250 Pa, as measured by a U-tube manometer, no more air is applied.

- Containers that cannot be pressurised to 250 Pa (the starting pressure for the test) fail the test and must be enclosed under gas-proof sheets to be fumigated.

Then the time taken for the pressure to fall from 200 to 100 Pa is measured.

- If the time is less than 10 seconds, the container fails the test and must be enclosed under gas-proof sheets to be fumigated.
- If the time is equal to or more than 10 seconds, the container is considered to be sufficiently gastight to allow its contents to be fumigated without enclosing it under gas-proof sheets.

### *Instruments required for pressure testing*

The equipment required is relatively simple:

- High-pressure air can be supplied from a compressor or gas cylinder.
- A **'finger manifold'** allows compressed air to be (i) delivered into a container, (ii) pressurise it and (iii) allow the pressure decay to be measured. The manifold is designed to be inserted under the door sill or between the container doors.

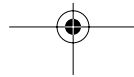
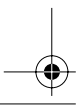
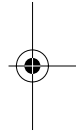
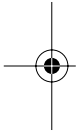

## GUIDE TO FUMIGATION UNDER GAS-PROOF SHEETS

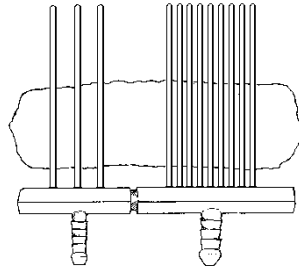

Finger manifold showing silicone sealant applied over and through the fingers to provide a gastight seal when used during pressure testing.

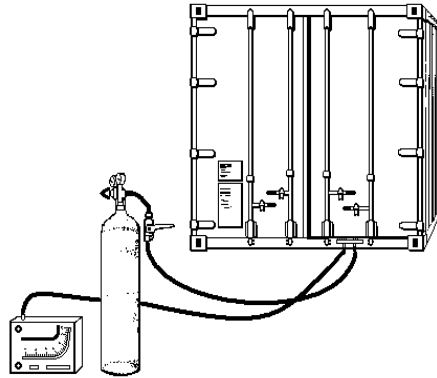

Finger manifold put in place between the door and floor sill showing connection to a compressed air cylinder and an inclined manometer.

- The pressure inside the container may be measured using a variety of instruments. The equipment required ranges from relatively simple to proprietary instruments, including:
  - a **simple U-tube manometer** with arms that are at least 20–30 cm long and a stopwatch
  - an **inclined manometer** and a stopwatch
  - any **sensitive pressure gauge** and a stopwatch
  - **purpose-made instruments** that combine a pressure sensor with a timer.



### GUIDE TO FUMIGATION UNDER GAS-PROOF SHEETS

Whatever instrument is used the procedure is as follows:

- pressurise the container
- when the pressure inside the container reaches 250 Pa, turn off the compressed air supply
- allow the pressure to decay to 200 Pa
- start measuring the time (in seconds) when it reaches 200 Pa
- stop measuring the time (in seconds) when it reaches 100 Pa.

U-tube manometer

Inclined manometer

0 Pa

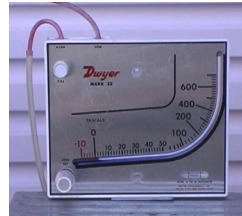
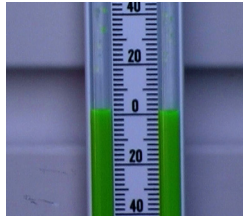

250 Pa

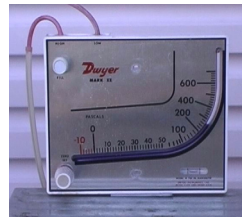
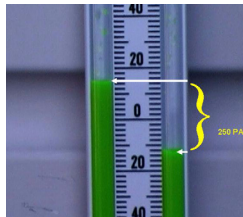

200 Pa

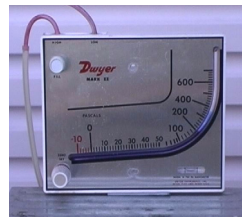
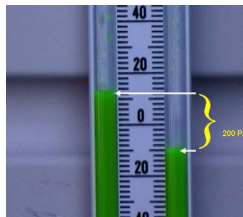

100 Pa

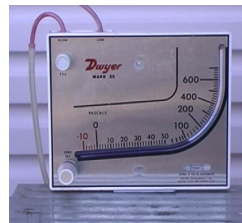
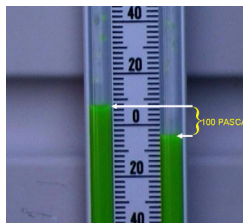

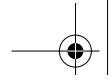

## GUIDE TO FUMIGATION UNDER GAS-PROOF SHEETS

---

In **best fumigation practice**, the enclosure is treated using all appropriate equipment, fumigants, and fumigation methods in accordance with OH&S, environmental, other regulatory requirements, and equipment and chemical manufacturers' specifications/instructions.

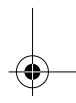
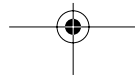
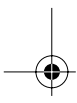
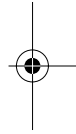
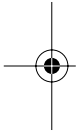





## 8 FUMIGATING WITH PHOSPHINE

### 8.1 The requirements for successful fumigation with phosphine

Fumigation with phosphine is generally considered to be much easier than fumigation with methyl bromide, because:

- phosphine is generated from solid metal-phosphide preparations (pellets, tablets, plates, sachets, chains, blankets etc.)
- these preparations are easy to introduce into an enclosure.

**Fumigators must not be misled by the apparent simplicity of this process.**

**In fact, the requirements for doing a successful fumigation with phosphine are very much more demanding than those for methyl bromide.**

The extra demands of phosphine fumigation arise because (in most cases) the dosages used with phosphine kill the larval and adult life stages of insects. These are called the 'susceptible life stages'. The eggs and pupae are not killed. These are called the 'tolerant life stages'. Increasing the dosage will **not** kill these life stages. These life stages are killed by allowing them to grow and develop into the next susceptible life stage – eggs to larvae, and pupae to adults – while they are inside the fumigation enclosure. This is why long exposure periods of up to 7–8 days (sometimes longer) are required when fumigations are done with phosphine.

In fumigation practice, this means that:

- the concentration of phosphine inside the enclosure must be held at a toxic level for long enough to allow eggs and pupae to develop through to larvae and adults

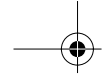

## GUIDE TO FUMIGATION UNDER GAS-PROOF SHEETS

- enclosures made with fumigation sheets must be sufficiently gastight to allow phosphine to be held at these concentrations for up to 7–8 days
- fumigation treatments where most gas is lost by about the fifth day will fail.

**Fumigators must remember that the exposure period is deemed to start from the time that the fumigant is first found to be evenly distributed inside the fumigation enclosure. In practice, this may add 2 more days to the overall exposure period — from time of gas addition.**

In **best fumigation practice**, the whole fumigation process is conducted using safe operating practices in accordance with OH&S, environmental, other regulatory requirements, and equipment and chemical manufacturers' specifications/instructions.

Repeated fumigation failures (treatments where eggs and pupae have not been killed) have already led to the development of resistance to phosphine in some insects, in some countries. There is a very real likelihood that this could lead to loss of phosphine as an effective fumigant if this process continues.

### **When to use and when not to use phosphine as a fumigant**

Phosphine may be used:

- when a commodity is required in not less than 7 days
- when *Trogoderma granarium* is present and use of methyl bromide is not compulsory
- when oilseeds, expeller cake, and meals are to be treated
- where germination is important
- where commodities have been treated previously with methyl bromide
- where taint may be a problem if methyl bromide is used; for example, on flour.



## GUIDE TO FUMIGATION UNDER GAS-PROOF SHEETS

Phosphine must **not** be used:

- when there is no trained, qualified, and properly protected fumigation team
- in unsealed enclosures
- where resistance to it is known to exist in an insect population
- when the temperature is below 15°C
- where a rapid treatment is required, i.e. less than 7 days
- in areas immediately adjacent to workspaces and places where people live.

### 8.2 The properties of phosphine as a fumigant

Phosphine may be sorbed by commodities and has great penetrative capacity. At normal dosages, phosphine appears to have virtually no effect on the germination of seeds held at safe moisture contents, but it may slightly reduce the vigour of subsequent seedlings. There is some evidence that phosphine may reduce germinability if applied to high-moisture grain.

Odour	Pure phosphine is odourless up to 200 ppm. Low concentrations of phosphine generated from metal phosphides have a 'garlic' or 'fishy' smell.
Specific gravity as a gas	1.17 (air = 1)
Flammability	Flammable gas
Lower limit of flammability	1.8% v/v
Method of evolution	1. From solid metal phosphide preparations 2. As a gas from cylinders
Chemical reaction	Phosphine is corrosive to copper, brass (and other copper alloys), gold and silver.

#### Odour

Pure phosphine is odourless at concentrations up to 200 ppm.

At concentrations down to less than the TLV of 0.3 ppm (0.4 µg/L or 0.42 mg/m<sup>3</sup>), phosphine generated from metal phosphide preparations has a 'garlic' or 'fishy' smell. It must be noted that this smell may be sorbed by the commodity or product being fumigated.

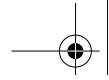

## GUIDE TO FUMIGATION UNDER GAS-PROOF SHEETS

Absence of odour does not necessarily indicate absence of phosphine, as the odorous impurities can be easily removed by adsorption onto the commodity being fumigated, leaving phosphine without a smell.

### In fumigation practice this means:

- fumigators must not rely on this smell to detect the presence or absence of phosphine. Always use a phosphine gas detector.

### Specific gravity

Pure phosphine is 1.17 times heavier than air. Phosphine, in the concentrations used for fumigation, disperses rapidly in air. The density of the resulting phosphine/air mixture is virtually the same as that of pure air. Consequently, the standards of gastightness required for effective fumigation with phosphine are high.

### In fumigation practice this means that:

- when phosphine is released into fumigation enclosures – at fumigation concentrations – the specific gravity of the final phosphine/air mixtures is not much greater than that of air
- it disperses very rapidly and penetrates deeply into large bulks of grain or tightly packed materials, and does not layer
- it is not necessary to use fans to distribute the gas inside the enclosure.

### Flammability

Phosphine is flammable, and will spontaneously ignite (catch fire by itself), at concentrations above 1.8% by volume (17,900 ppm or 24.9 mg/L or 24.9 g/m<sup>3</sup>). Because of this, phosphine-generating products must never be used under conditions that would allow the gas concentration to reach this level.

Commercial phosphine-generating products (tablets, pellets, sachets etc.) contain substances that are claimed to either (i) reduce the fire hazard, or (ii) control the rate of phosphine production, so limiting the concentration of phosphine released close to the generating product.

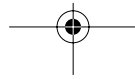

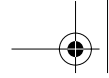

## GUIDE TO FUMIGATION UNDER GAS-PROOF SHEETS

**To prevent any possibility of ignition in fumigation practice this means that:**

- phosphine-generating products (for example, tablets, pellets, sachets, blankets) must not be heaped into piles when they are introduced into a fumigation enclosure
- phosphine-generating products must not be allowed to come into contact with water at any time
- phosphine-generating products must be kept away from naked flames
- equipment that may cause sparks must not be used while doing a fumigation with phosphine.

When used according to label directions, the amount of gas produced by phosphine-generating formulations remains far below the lower flammability level.

### **Chemical reaction**

Phosphine is slightly soluble in water and has low solubility in most solvents. Phosphine is corrosive to copper, brass (and other copper alloys), gold and silver. The effect is increased in the presence of moisture or ammonia (produced when phosphine is generated from tablets, pellets, sachets, blankets etc.), and salt air (in coastal environments).

**In fumigation practice this means that:**

- equipment and machinery containing copper (for example, electrical apparatus, computers, machines etc.) may be severely damaged when exposed to phosphine
- care must be taken to identify such items (e.g. electrical switching gear, computers, and electronic equipment) before a fumigation, and action must be taken to seal, cover or remove them before fumigation with phosphine. Where this is impossible, treatment with an alternative fumigant must be considered.

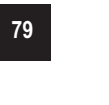
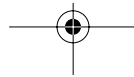
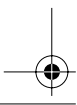
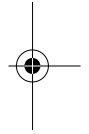
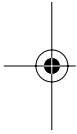

GUIDE TO FUMIGATION UNDER GAS-PROOF SHEETS

Phosphine gas concentrations – conversion table (at 25°C)

ppm	% (v/v in air)	g/m <sup>3</sup>
0.3	0.00003	0.0004
1.0	0.0001	0.0014
718	0.072	1.0
1,436	0.144	2.0
3,590	0.36	5.0
10,000	1.0	13.9
17,900	1.8	24.9

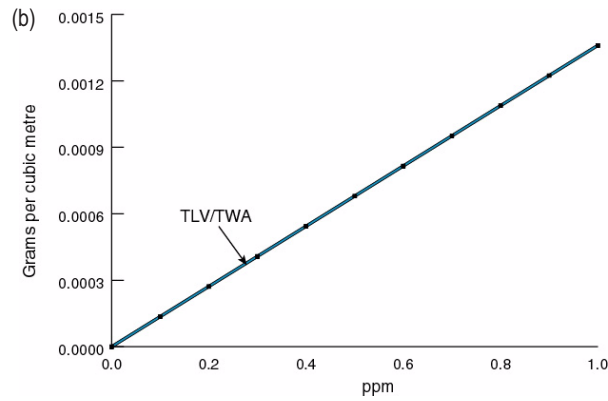
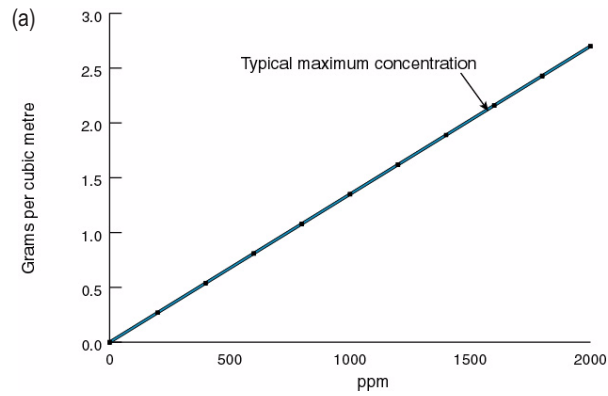

Graphs giving: (a) conversion of phosphine parts per million (ppm) – at levels normally achieved during fumigation exposures – to phosphine grams per cubic metre (g/m<sup>3</sup>) at 25°C; (b) conversion of phosphine parts per million (ppm) – at levels relevant to human safety – to phosphine grams per cubic metre (g/m<sup>3</sup>) at 25°C.



## GUIDE TO FUMIGATION UNDER GAS-PROOF SHEETS

### 8.3 Safety rules for fumigators using phosphine

Fumigation is a precise operation requiring considerable expertise, and it cannot be undertaken without proper preparation. It is important that management and their fumigators-in-charge understand this, and ensure that proper planning is carried out before a fumigation treatment is done.

1. Are you allowed to do a fumigation with phosphine in your country?
  - Have you been trained to do fumigations with phosphine?
  - Do you have the practical experience needed to do a treatment without supervision?
2. Check *all* national and local government rules and regulations telling you *how to do fumigations in your country*. Make sure you understand them.
3. Check *all* national and local government rules and regulations about *use of phosphine in your country*. Make sure you understand them.
4. Do you know and understand when to apply the dosage rates for phosphine recommended in your country?
5. Can you recognise the symptoms of phosphine poisoning?
6. Check all equipment before you use it. Make sure it is all in good working condition.
  - Examine all gas-proof sheets by suspending them over a lighted doorway. Repair even the smallest holes that could cause gas leaks, since these leaks could result in human injury or insufficient gas concentration to control the target pest.
  - For gas cylinders, make sure you have (i) a washer to fit the gas outlet of the cylinder, and (ii) the correct fittings to connect the gas-delivery pipe to the cylinder. Check and repair these, if necessary.
  - Make sure you have enough phosphine-generating product to do the treatment.



## GUIDE TO FUMIGATION UNDER GAS-PROOF SHEETS

- Make sure that there are enough sand snakes to seal the enclosure. There must be enough to go around the enclosure twice.
  - Make sure enough trays are available to put tablets (or pellets) on.
  - Make sure a fully equipped tool kit is available.
- 7. Go and inspect the place where the fumigation will be done.**
- Is it sheltered from strong wind? If not, can it be moved and rebuilt?
  - Is the stack built on a gas-proof floor?
  - Are you sure there are no drains under the stack?
  - Can the enclosure be sealed properly?
  - Has the stack been built around a pillar? If so, rebuild the stack.
  - Is there enough space between the stack and the walls?
  - **Are there any connecting godowns?**
  - **Identify all houses around the danger area where people live. Will the people who live in them be safe during the exposure period?**
  - **Identify any items that could be damaged by phosphine and make sure they are removed before the fumigation starts.**
- 8.** If it is possible to do a fumigation:
- is there enough time to do the fumigation properly?
  - can the fumigation be done at a time when workers are not present?
  - can the enclosure be aerated at a time when workers are not present?
  - is it possible to close off the danger area?
  - is it possible to safely aerate the enclosure at the end of the exposure period?
  - is electricity available so that fans can be used to aerate the enclosure at the end of the exposure period? If not, a portable generator will be required.





## GUIDE TO FUMIGATION UNDER GAS-PROOF SHEETS

### 9. Emergency actions

- Look for and identify all safe ways to get out of the fumigation area in an emergency.
- Identify emergency doors, connecting godowns, a water supply.
- Identify the nearest telephone, the nearest hospital, the nearest doctor, the nearest fire brigade.
- Find the quickest way to the nearest hospital.
- Make sure two trained persons will be present at all times during the fumigation.

### 10. Develop a fumigation plan

- Tell all fumigation staff:
  - how the fumigation will be done
  - how to leave the fumigation area *safely* in case of emergency
  - what to do if any person breathes in phosphine gas
  - what to do if any person breathes in or comes into contact with dust produced by phosphine-generating product
  - who will monitor gas concentrations in the workspace.
- All people involved with the fumigation must be shown around the fumigation site. If there is a safer way to do anything, revise the fumigation plan.

### 11. Make sure all fumigation staff:

- know what first aid action to take in case anyone is injured
- are equipped with, and know how to use personal-protection equipment appropriate for fumigation with phosphine (self-contained breathing apparatus, gas masks)
- understand that *gloves must be worn while (i) opening and handling containers of generating product, and (ii) dispensing the product by hand.*

### 12. Before a fumigation is started, be sure that the nearest doctor (or hospital) has instructions on how to treat injuries caused by phosphine.

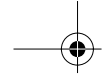

## GUIDE TO FUMIGATION UNDER GAS-PROOF SHEETS

---

13. Where necessary, the fumigator-in-charge must make sure that all national and local government agencies (for example, the police, the fire brigade, the nearest hospital etc.) that might be involved with the fumigation treatment, have been told where and when the fumigation treatment will be done.
14. Check weather conditions before fumigation.
  - If it is possible that wind will damage fumigation sheets, delay the fumigation until the treatment can be done safely or take other precautions.
15. Fumigators must not consume alcohol less than 24 hours before the start of a fumigation treatment.
16. Warning signs
  - Always put warning signs (in appropriate languages) around the danger area at a fumigation site. Include an emergency telephone contact number on the signs.
  - The signs must be at places where people are most likely to see them.
  - Guards must be used if required by government (or other) regulation.
17. Containers (tins, canisters) of phosphine-generating products must always be opened in the open air, because concentrations of gas may build up in them.
  - To avoid inhaling the gas, fumigators must make sure that containers are pointed away from them when they open such containers.
18. *Do not* eat, drink or smoke at any time when doing a fumigation with phosphine, especially while handling and distributing phosphine-generating products.
19. To prevent spontaneous ignition of phosphine-generating products (tablets, pellets, sachets etc.):
  - *do not* place phosphine-generating products on wet grain

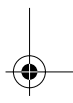
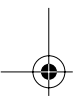
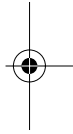



## GUIDE TO FUMIGATION UNDER GAS-PROOF SHEETS

- *do not* place phosphine-generating products on wet surfaces or surfaces that may get wet
  - *do not* heap tablets or pellets when distributing them for a fumigation.
- 20.** To prevent contamination:
- *do not* allow phosphine-generating products or their breakdown products (spent residues) to come into contact with any food or feed commodity.
- 21.** Monitoring
- Always use leak-detection equipment to check that the workspace is safe and the enclosure is well-sealed.
- 22.** Repeated small exposures to phosphine can be dangerous. Always plan ways to *minimise unprotected exposure to phosphine*.
- 23.** If anyone gets sick during fumigation, with symptoms of or similar to phosphine poisoning, do not take chances. Take the person to a doctor and let the doctor decide the cause of the illness (see Sections 8.5 and 8.6).
- 24.** Clothing
- After a fumigation, fumigators must wash thoroughly and change their clothes immediately.
  - Clothing contaminated with dust produced by phosphine-generating products must be aired overnight in an open area before it is washed.
  - *Do not* leave contaminated clothing, shoes and other equipment in confined areas such as motor cars, cupboards or rooms.
  - Dirty clothing worn by fumigators must be washed separately from other clothes, especially infants' clothes.
- 25.** Aeration
- Aeration must be done in stages, to avoid sudden release of large amounts of fumigant.

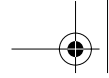

## GUIDE TO FUMIGATION UNDER GAS-PROOF SHEETS

26. Disposal of spent residues
  - Spent residues must be disposed of according to local regulations in your country or, in the absence of such regulations, in accordance with the manufacturer's instructions.
  - *Do not* flush residues into sewers or septic tanks.
27. Disposal of empty containers
  - Containers in which phosphine-generating products are supplied must be disposed of so that they cannot be re-used. This must be done in accordance with local regulations in your country or, in the absence of such regulations, in accordance with the manufacturer's instructions.
28. Clearance
  - Clearance after aeration must be issued only when monitoring instruments show that gas concentrations have fallen to, or are below, the TLV set for phosphine in your country.
29. The fumigator-in-charge must make sure that all national and local government agencies (for example, the police, the fire brigade, the nearest hospital etc.), that might be involved with the fumigation treatment, have been told that the fumigation has ended.
30. Warning signs
  - After clearance has been given at the end of the aeration period, *remove all warning signs*.
  - If signs are not removed, people will ignore them during the next fumigation.
31. Promptly return all empty phosphine cylinders to the supplier.

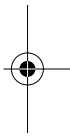
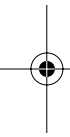

**Never give or sell fumigants to untrained persons.**



## GUIDE TO FUMIGATION UNDER GAS-PROOF SHEETS

## 8.4 Personal-protection equipment for use during phosphine fumigations

Fumigators must always comply with national and local government regulations covering personal-protection equipment required during fumigation treatments with phosphine.

Where no such regulations exist, the recommendations below provide a guide to the essential items of personal-protection equipment.

### Respiratory protection

Fumigators and other persons at risk from inhaling excessive quantities of phosphine must be provided with either a full-face canister respirator or an open-circuit, self-contained breathing apparatus with a full face mask. Respiratory protection must be worn whenever tests of the atmosphere reveal concentrations of the gas greater than the hygienic standard (currently 0.3 ppm v/v in most countries).

Masks and filter canisters must be issued on a personal basis, and a register of use maintained by the fumigator-in-charge.

Canister respirators must never be worn for entry into the fumigation enclosure itself. If this is ever necessary, self-contained breathing apparatus must be worn.

#### *Canister respirators*



Canister respirators must be fitted with a filter canister designed for protection against phosphine, as recommended by national and local government regulations. Each time a respirator of this type is put on



### GUIDE TO FUMIGATION UNDER GAS-PROOF SHEETS

for use, the facial fit must be tested by closing the inlet to the canister with the palm of the hand and inhaling deeply; the vacuum so created must cause the face-piece to adhere to the face for about 15 seconds.

With this type of respirator it is essential that the filter canister be used within its stated shelf life. The filter canister must always be replaced before either its shelf life has expired or the recommended usage time has been reached. The expiry date of a filter canister may easily be calculated since each is marked with the date of manufacture and its shelf life.

Filter canisters must be stored in a cool, dry, well-ventilated place away from contamination by any fumigants. The following precautions must always be observed:

- When the canister is attached to the respirator face-piece after the top seal is removed, record the date. This is best done by writing the date on a small, adhesive label which must be affixed to the canister. This label can be used as a 'log' to record exposure of the canister to the fumigant.

Date attached to mask <i>01/02/03</i>		Time available (initially 120 minutes)
Date used	Time used	

- Before using the respirator, remove the cap and the seal over the air inlet valve of the canister. Again, at this time mark the date on the 'log' label. Once this seal is removed, even if there is no



### GUIDE TO FUMIGATION UNDER GAS-PROOF SHEETS

exposure to fumigant, dispose of the canister when 6 months has elapsed

Date attached to mask <i>01/02/03</i>		Time available (initially 120 minutes)
Date used	Time used	
<i>01/02/03</i>	<i>30</i>	<i>90</i>
<i>02/02/03</i>	<i>45</i>	<i>45</i>
<i>05/02/03</i>	<i>40</i>	<i>5</i>

- After any fumigation in which there has been (i) prolonged exposure to low concentrations of the fumigant or (ii) accidental exposure to high concentrations, immediately discard the canister. As a guide, 1 hour of wearing is the usual period after which a canister must be discarded. This could be extended to 2 hours, but only when exposure is minimal. Allow a wide margin of safety in estimating exposure times, as canisters cost little in terms of health of the individual. If there is any doubt about the exposure life of the canister, discard it.
- Canisters must be resealed with the original top and bottom seals between uses. When canisters are discarded, they must be made unusable by damaging the inlet port, and disposed of in a way that will prevent them from being picked up and used again.
- Canisters that show any sign of external damage must be considered worthless, and must be discarded. A severe blow on the metal covering may cause displacement of the contents, permitting contaminated air to pass through to the wearer.
- Immersion of the canister in water makes it useless. To prevent water entering the canister through the face-piece, always disconnect the hose and/or canister when cleaning or disinfecting the face-piece.



## GUIDE TO FUMIGATION UNDER GAS-PROOF SHEETS

### *Self-contained breathing apparatus*

Self-contained breathing apparatus must be available for all uses of phosphine above 15 ppm. The facial fit of this type of apparatus may be tested in the same way used for canister respirators, except that the cylinder valve is closed before deep inhalation.

### **Skin protection**

Gloves, preferably cotton, must always be worn when phosphine-generating tablets, pellets, or sachets are handled. Cotton gloves are less likely to cause sweating than are plastic gloves. Cotton gloves must be washed after use.



**Persons who have to wear full-face respiratory-protection equipment during a fumigation treatment must be clean shaven, to ensure the best possible gastight fitting to the face.**

**Persons who need to wear prescription glasses while using a respirator must obtain special, armless lens frames that are made specifically to fit inside the visors of such equipment.**





## GUIDE TO FUMIGATION UNDER GAS-PROOF SHEETS

In **best fumigation practice**, suitable personal protective equipment is selected and used in accordance with OH&S, environmental, other regulatory requirements, and equipment and chemical manufacturers' specifications/instructions.

### 8.5 Safety precautions

#### Phosphine gas

Phosphine is highly toxic, and exposure to even small amounts must be avoided. Poisoning and death can result from inhalation of the gas. Very brief exposures to a concentration of 2.8 mg/L or 2.8 g/m<sup>3</sup> (approximately 2000 ppm) are lethal to humans.

Inhalation of the gas may produce symptoms including nausea, vomiting, diarrhoea, headache, and chest pain.

It is not absorbed through the skin.

**The threshold limit value–time weighted average (TLV–TWA) exposure standard for phosphine is 0.3 ppm (0.4 µg/L or 0.4 mg/m<sup>3</sup>). This is the average airborne concentration of phosphine when calculated over a normal 8-hour working day, for a 40-hour working week, although the use of average concentrations permits excursions above this limit. In operational terms, the aim must be to treat this value (0.3 ppm) as the maximum acceptable limit.**

**In many countries, the threshold limit value–short term exposure limit (TLV–STEL) for exposures not exceeding 15 minutes is 1 ppm (1.3 µg/L or 1.3 mg/m<sup>3</sup>), *providing that there are not more than 4 exposures per day and there is more than 60 minutes between exposures.***

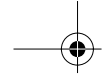

## GUIDE TO FUMIGATION UNDER GAS-PROOF SHEETS

The following maximum residue limits (MRLs) for phosphine *residues in grain* (including those in the form of unspent aluminium phosphide), have been established in some countries:

- unprocessed grains: 1 ppm (1 mg/kg)
- processed grains: 0.1 ppm (0.1 mg/kg).

### **Aluminium phosphide and magnesium phosphide phosphine-generating products**

Phosphine-generating products are very dangerous. They can kill if swallowed. They release phosphine gas slowly in moist air, and rapidly when wet. Phosphine gas can kill if inhaled.

**Do not** eat, drink or smoke while handling phosphine-generating products.

Containers (tins, canisters) holding phosphine-generating products must be opened in the open air, because concentrations of gas may build up in them. To avoid inhaling the gas, care must be taken to ensure that containers are pointed away from the fumigator opening them. Occasionally, with poorly stored or improperly sealed containers, the gas may ignite and 'flame' as the container is opened.

Gloves must be worn while opening and handling containers of generating product, and while dispensing the product by hand.

**Do not** inhale any dust produced by the generating compounds, and **avoid contact** with eyes and skin. Wash contaminated bare skin thoroughly with soap and water. If in eyes, flush with plenty of water and get medical attention.

Clothing contaminated with the dust produced by generating compounds must be aired overnight in a well-ventilated area before laundering. Contaminated shoes must be brushed off in a well-ventilated area. **Do not** leave contaminated clothing, shoes and other equipment in confined areas, such as motor cars, vans, lockers, rooms etc.

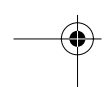
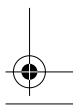
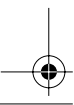
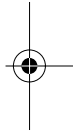

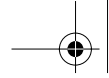

## GUIDE TO FUMIGATION UNDER GAS-PROOF SHEETS

Neither phosphine-generating products (aluminium phosphide or magnesium phosphide) nor their breakdown products (the spent residues) must be allowed to come into contact with any food commodity.

**Do not** inhale the gas evolved from the generating product.

To prevent any possibility of spontaneous ignition, **DO NOT** heap tablets or pellets when dispensing them for a fumigation.

It must be noted that spent aluminium phosphide still contains 3–5% unreacted aluminium phosphide.

The residues – both spent and unspent – obtained from phosphine-generating products after a fumigation must be disposed of with care. All residues, particularly unspent residues, must be deactivated in an approved manner before disposal. Spent residues must be disposed of at approved sites such as sanitary landfills or pesticide disposal sites, or by other procedures approved by the local or state authorities.

**Do not** flush residues into sewers or septic tanks.

Store phosphine-generating products in a cool, dry, well-ventilated and locked area, out of reach of children or unauthorised persons, and away from all dwellings.

Keep phosphine-generating products away from water and liquids, which can cause immediate release of phosphine and may result in fire or explosion.

Keep phosphine-generating products away from naked flames, because high concentrations of phosphine are explosive. For the same reason, while fumigating with phosphine do not use any equipment that may cause sparks.

The product must never be used under conditions that would allow the gas concentration to reach the lower limit of flammability, which is 1.8% by volume (17,900 ppm or 24.9 µg/L or 24.9 mg/m<sup>3</sup>).

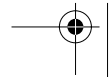
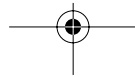
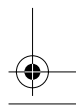
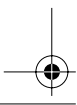
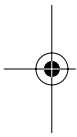

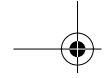

## GUIDE TO FUMIGATION UNDER GAS-PROOF SHEETS

---

When used according to label directions the amount of gas produced remains far below the lower flammability level.

In **best fumigation practice**, the whole fumigation process is conducted using safe operating practices in accordance with OH&S, environmental, other regulatory requirements, and equipment and chemical manufacturers' specifications/instructions.

### 8.6 First aid

The symptoms of phosphine poisoning include:

- nausea
- vomiting
- diarrhoea
- chest pain
- headaches
- stomach pains.

Any person with these symptoms at a fumigation site should be taken to a doctor or hospital for emergency treatment.

Any person who appears to have been affected by phosphine (by inhaling the gas or dust from a generating product) must be taken at once into fresh air, kept warm, and medical attention obtained. If breathing stops or shows signs of failing, resuscitation must be commenced immediately.

There is no specific antidote for phosphine poisoning.

**Do not** administer any milk, butter, oils (e.g. castor oil), or alcohol.

No one must enter an area under fumigation, except in extreme emergency, and then only if wearing adequate respiratory protection.

Self-contained breathing apparatus is the preferred method in emergencies.

#### **Note to physician**

Aluminium (or magnesium) phosphides react with moisture in the air, acids and many other liquids to release phosphine gas.



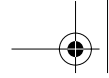

## GUIDE TO FUMIGATION UNDER GAS-PROOF SHEETS

---

Mild exposure by inhalation causes:

- malaise
- ringing in the ears
- fatigue
- nausea
- pressure in the chest, which is relieved by removal to fresh air.

Moderate poisoning causes:

- weakness
- vomiting
- chest pain
- diarrhoea
- dyspnoea.

Severe poisoning may occur in a few hours to a few days, resulting in pulmonary oedema and may lead to:

- dizziness
- cyanosis
- unconsciousness
- death.

In sufficient quantities, phosphine affects the liver, kidneys, lungs, nervous system, and circulatory system. Inhalation can cause lung oedema and hyperaemia, small perivascular brain haemorrhages and brain oedema. Ingestion can cause lung and brain symptoms, but damage to the viscera is more common. Phosphine poisoning may result in (1) pulmonary oedema; (2) elevated SGOT, LDH and alkaline phosphatase, reduced prothrombin, haemorrhage and jaundice; and (3) kidney haematuria and anuria. Pathology is characteristic of hypoxia. Frequent exposure over a period of days or weeks may cause poisoning. Treatment is symptomatic.

In **best fumigation practice**, the response to emergency situations with fumigants is made using emergency procedures in accordance with OH&S, environmental, other regulatory requirements, and equipment and chemical manufacturers' specifications/instructions.

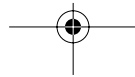
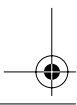
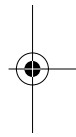
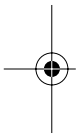

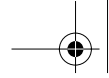

## GUIDE TO FUMIGATION UNDER GAS-PROOF SHEETS

### 8.7 Phosphine dosage rates

#### Choosing the correct dosage

To choose the correct dosage for the product that you want to fumigate, look for and read the manufacturer's label, which is attached to the container of phosphine generating product you are using. This label contains specific information that tells you:

- how the product should be applied
- what products it can be used for
- how much to apply for each product or group of products
- the length of the exposure period for each product or group of products
- the length of the withholding period.

The dosages on the label may be presented in two ways:

1. as *an amount of fumigant gas per unit of volume of space/ enclosure*, usually given as grams per cubic metre, which is abbreviated as **g/m<sup>3</sup>**
2. as *an amount of fumigant gas per unit of weight of commodity*, usually given as grams per tonne, which is abbreviated as **g/t**.

Remember also that dosage recommendations consist of two parts (i) the amount of phosphine generating formulation that must be put into the fumigation enclosure *and* (ii) the length of the exposure period.

Read the label carefully then carefully select and calculate the dosage in accordance with the instructions on the label.

If you have any difficulty understanding the label or if a product is not listed on the label, always seek the advice of the relevant national agricultural chemicals registration agency – before you start the fumigation.

#### Phosphine produced by metal-phosphide products

The amount of phosphine gas released by metal-phosphide products varies.

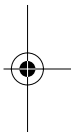
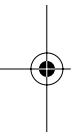

## GUIDE TO FUMIGATION UNDER GAS-PROOF SHEETS

### *Aluminium phosphide*

The amount of phosphine released by aluminium-phosphide products is usually 33% of the total weight of the product. Formulations usually contain 55–60% aluminium phosphide. Fumigators must read the manufacturer's label on the product they are using, to find out the exact amount of phosphine (in grams) released by that formulation.

The following information can be used as a rough guide:

- tablets weigh approximately 3 grams and release 1 gram of phosphine gas
- pellets weigh approximately 0.6 grams and release 0.2 grams of phosphine gas.

### *Magnesium phosphide*

The amount of phosphine released by magnesium-phosphide products is 33% of the total weight of the product. Formulations usually contain 66% magnesium phosphide.

### **The amount of phosphine required**

When doing fumigations with phosphine, fumigators must understand that the chances of success in a poorly sealed enclosure *are always low*.

This is because it is effectively impossible to make up for leakage by increasing the dosage beyond the rate recommended on the label.

**Increasing the dosage above the rate(s) recommended on the label will not compensate for poor gastightness.**

In **best fumigation practice** the dosage is *selected* and *calculated* accurately in accordance with:

- the manufacturer's specifications/instructions
- the client's requirements
- OH&S, environmental, and other regulatory requirements.

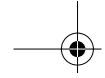

## GUIDE TO FUMIGATION UNDER GAS-PROOF SHEETS

### Exposure period for fumigations done with phosphine

Scientific research has shown that complete disinfestation in fumigations done with phosphine *cannot be guaranteed with exposure periods shorter than 8 days at temperatures above 25°C or 14 days below 20°C.*

- Many insect species are killed after 5 days.
- However, even at 25°C, more-tolerant species such as grain weevils (*Sitophilus* spp.), bean weevils (bruchids) and certain psocid species require a 7–10-day exposure period to kill all life stages.
- Even longer exposure periods (10 days or longer) are required to kill other insects, including the eggs of some species of psocids.

**Fumigators must always ignore recommendations for 3-day exposure periods that appear on the labels of some phosphine-generating products. Such shortened exposure periods are very unlikely to be successful, and can lead to the development of insect resistance to phosphine. In addition, fumigators will be exposed to dangerously high concentrations of phosphine when they open the enclosure to aerate it.**

### Record keeping

All details relevant to the dosage applied during a fumigation must be recorded on an appropriate 'record of fumigation'. These must include:

- the dosage chosen for the treatment
- the calculations made to decide on the total amount of phosphine required for the treatment.





## GUIDE TO FUMIGATION UNDER GAS-PROOF SHEETS

## 8.8 Introducing phosphine into an enclosure

### Preparations before gassing an enclosure with phosphine

Before starting to introduce phosphine into an enclosure, it is important to:

- plan how the phosphine-generating formulation will be distributed inside the enclosure
- plan how the enclosure will be ventilated safely at the end of the exposure period
- take action to protect any materials and equipment (electrical apparatus, computers, machines etc.) containing copper that may be damaged by exposure to phosphine gas during the exposure period and ventilation process
- measure the stack to be fumigated, work out the volume, then calculate the dosage based on its volume (which is more effective than dosages based on weight of commodity)
- mark out the danger area around the fumigation enclosure
- put warning signs on the enclosure and around the danger area.

### Equipment required

- Appropriate personal-protection equipment, including gas masks and canisters suitable for use with phosphine, or self-contained breathing apparatus (SCBA), rubber gloves, and overalls must be available for all staff.
- Enough phosphine-generating preparation to make up the required dosage.
- Cardboard or plastic trays (about 30 × 30 cm) into which to place the tablets or pellets.

### Opening containers of phosphine-generating formulations

Containers (tins, flasks etc.) containing phosphine-generating products must always be opened with care. This is because phosphine gas is sometimes generated inside the container. When the container is opened, the gas escapes under pressure, and may ignite.

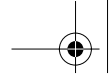

## GUIDE TO FUMIGATION UNDER GAS-PROOF SHEETS

To prevent exposure to the gas or a flame, make sure that the container is held so that the lid points away from the face of the person opening it. Always ensure that there are no naked flames anywhere near the area where the container is opened.

### Dispensing phosphine-generating formulations

#### *Tablets or pellets*

When tablets or pellets are used, they must be placed in cardboard or plastic trays so that:

- the commodity is not contaminated by spent residues (the dust left after phosphine has been released)
- the spent residues can be collected and disposed of safely.

Trays containing tablets or pellets must be distributed evenly around the base of the stack.

- Where a stack is built on pallets, they can be placed under the pallets.
- Where no pallets are used, they may be placed along the sides of the stack.

It is not necessary to place tablets at the top of the stack, or in the spaces between bags.

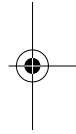
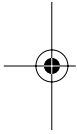

When placing tablets or pellets in trays, it is important to make sure they are evenly spread out on the tray, in a single layer. This is because if they are piled or heaped up:

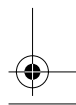
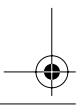

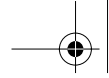

## GUIDE TO FUMIGATION UNDER GAS-PROOF SHEETS

- the phosphine may ignite when high concentrations of gas that exceed the lower limit of flammability are generated
- the tablets or pellets at the bottom of the heap are prevented from decomposing fully, because they are covered by spent residues from the tablets or pellets on the surface of the heap.

### *Sachets, blankets or chains*

When sachets, blankets or chains of phosphine-generating formulations are used these must be attached to the sides of the stack, but tucked away so as not to touch the covering sheet. This is to avoid contact with any condensation forming on the sheet as a result of temperature fluctuations.

### *Plates*

If plates are used, these also must be attached to the sides of the stack.

When placing any phosphine-generating formulation around the base of the stack, care must be taken to:

- protect them from making contact with water, by placing them in waterproof trays
- make sure there is enough space to allow free air circulation
- make sure fumigation sheet(s) are not held tightly against them.

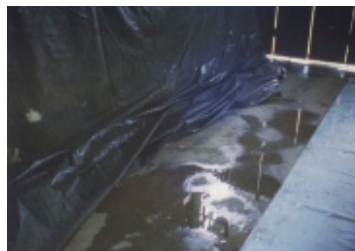
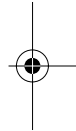
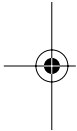

Water lying on fumigation sheets after a rainstorm.

**Phosphine-generating preparations can catch fire if they make contact with water.**

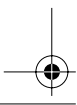

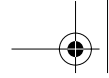

## GUIDE TO FUMIGATION UNDER GAS-PROOF SHEETS

Before any container(s) of phosphine-generating formulation is opened it is essential that:

- the fumigation sheets are in place, completely covering the stack
- the corners of fumigation sheet(s) are already sealed to the floor
- enough sand snakes to seal the sheets to the floor are distributed round the base of the stack.

When this has been done, *unopened* containers of phosphine-generating formulation are distributed where required around the stack.

Teams of two or three persons then work their way around the sides of the stack (from the back of the storage towards the exit doors), distributing and placing phosphine-generating formulation inside the enclosure in the following manner:

- the first person lifts the sheet
- the second person opens the container and places the phosphine-generating product under or along the sides of the stack
- the third person seals the fumigation sheets to the floor with a double row of sand snakes.

### Distributing the fumigant inside the enclosure

Pure phosphine is 1.17 times heavier than air. However, when applied at the concentrations required for fumigation, the phosphine-air mixture is not much heavier than air.

This is because it mixes very rapidly with air and very rapidly penetrates large stacks of grain and tightly packed materials.

For this reason it is not necessary to:

- distribute phosphine-generating preparations on top of a stack
- use fans to distribute the gas inside a sheeted enclosure.

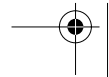
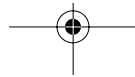
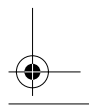
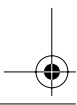
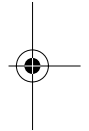
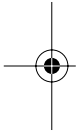



## GUIDE TO FUMIGATION UNDER GAS-PROOF SHEETS



**Phosphine-generating formulations must not be placed directly on to bags or grain because their spent residues can contaminate the grain and be a health hazard for people who handle bags.**

### Safety precautions

- The generation of phosphine generated from aluminium-phosphide formulations may be delayed by between 15–30 minutes after they are exposed to air.
- Phosphine is generated more rapidly from magnesium-phosphide formulations.

Because of this:

- appropriate personal-protection equipment must be used, including respiratory protection, gloves, and appropriate clothing
- the process of distribution must be done carefully but rapidly, to avoid exposure to phosphine
- in hot, humid, tropical areas this process must be completed within 15 minutes.

After the phosphine-generating formulation has been distributed inside the enclosure, the enclosure must be checked for leaks using a leak detector or appropriate monitoring equipment.

**In hot, humid conditions, phosphine is produced almost immediately on exposure to the air, so the dispensing process must be completed within 15 minutes.**



## GUIDE TO FUMIGATION UNDER GAS-PROOF SHEETS

### 8.9 Monitoring for phosphine

Monitoring phosphine gas concentrations allows the fumigator to find out:

- if enough gas has been added to the enclosure
- when the gas inside the fumigation enclosure is evenly distributed (in equilibrium) and to start timing the exposure period
- if the gas is leaking out of the enclosure
- if it is necessary to top-up the dosage to make sure that the fumigation treatment will be successful
- find out if the target end-point concentration has been reached.

Fumigators must be aware that:

- high levels of carbon monoxide can cause incorrect readings in some instruments commonly used to measure phosphine concentrations.

### 8.10 Fumigation of small quantities of grain with phosphine

It is often necessary to fumigate small quantities of grain, for which the fumigation sheets used to enclose bag-stacked products are excessively large and heavy.

The need to fumigate small quantities of bags occurs in situations where grain and other commodities are bought, stored, and sold.

There are many occasions when this may occur. For example:

- when spillage collected from bag-stacks in large, grain storage warehouses has to be disinfested more frequently than the bag-stacks from which it has fallen
- where high-value commodities such as cardamom, nutmeg, pepper, and other spices are traded in small quantities
- where small quantities of seed for growing have to be stored from one season to the next
- in rural towns and villages, where merchants buy and store small quantities of grain that may be infested
- on farms where grain may be stored.



## GUIDE TO FUMIGATION UNDER GAS-PROOF SHEETS

The method described here can be used to effectively fumigate one tonne lots of grain and other commodities bagged in 10 large, jute bags. The following materials are needed:

- a pallet; if pallets are not available, bricks (22) and planks (3–5) may be used to construct a platform
- polyethylene tubing; 0.2 mm thick, 3 metres long, 4.24 metres circumference (when plastic tubing is sold it is packed and folded flat so it would be about 2.1 metres wide)
- phosphine-generating tablets.

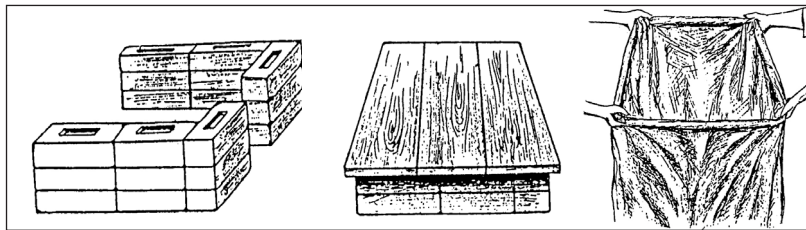

### The process has five steps:

1. The bags should be stacked on a pallet raised 30 cm above the floor.
  - In godowns and warehouses, pallets may be used.
  - Where no pallets are available, a platform can be built using bricks and planks as illustrated above.
  - If a platform has to be built, the planks must extend about 30 cm beyond the bricks supporting the platform.
  - There must be no gaps between the planks making up the platform.
  - If pallets are used, the spaces between the planks must be filled with extra planks.
2. The polyethylene tube is opened and rolled, leaving the last 0.5 metre unrolled. This is best done by two persons working together.
3. The rolled polyethylene tube is placed on the floor around the outer edges of the pallet, with the unrolled part covering the pallet.

## GUIDE TO FUMIGATION UNDER GAS-PROOF SHEETS

- The open edges of the unrolled end of the tube are pulled together and joined by rolling them tightly together 3–4 times, in a straight line over a plank on the platform.

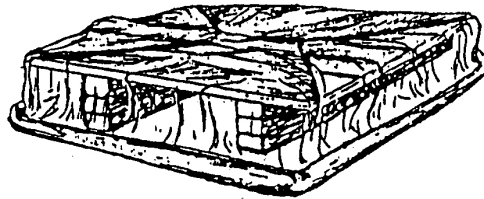

4. Now the first bags are placed on the pallet directly over the joined bottom edges of the tube to weight them down and force them together, to provide a gastight seal.

**Note.** To prevent rodents chewing through the plastic tube, the bags must be laid so they slightly overhang the sides of the platform. The objective is to leave no space for rodents to get onto the platform, as shown in the following two illustrations.

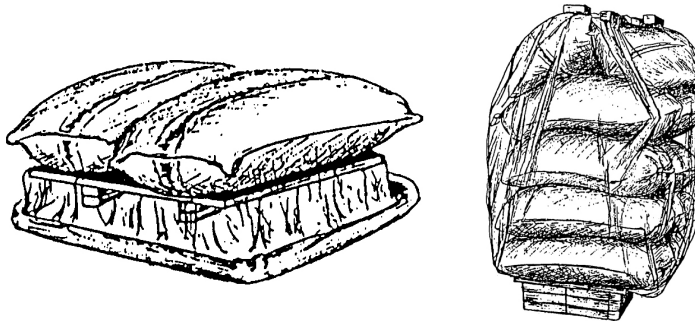

5. The remaining bags are stacked on the pallet and enclosed inside the plastic tube.
  - The bags must be stacked so that they will not fall.
  - The plastic tube should then be unrolled until it extends over the top of the bags.
  - When this has been done, the required dosage of phosphine-generating tablets is applied.



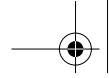

## GUIDE TO FUMIGATION UNDER GAS-PROOF SHEETS

- Immediately thereafter, the open edges of the unrolled end of the tube are pulled together and joined by rolling them tightly together down onto the bags.
- The roll is weighted down and held together with sand snakes or bricks.

To prevent rodents chewing through the enclosure:

- it must be located at least 0.5 metre from any walls
- the plastic tube must be pulled up tight, so no loose plastic material hangs or sags over the bottom of the pallet.

This is illustrated in the photograph below.

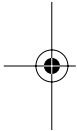

### Improving the gastightness of the system

When this method of fumigating small quantities of grain is regularly used in large, grain-storage godowns or warehouses, the gastightness and reliability of the seal made at the ends of the tube can be greatly improved by:

- pre-cutting and heat-sealing 'the bottom end' of the 3 metre lengths of polyethylene tubing
- rolling the ends of the polyethylene tubing, at the bottom of the enclosure, between two, long and narrow, flat pieces of wood (e.g. plywood or smooth split bamboo) whose ends are fastened together with string

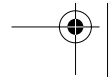
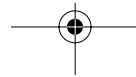
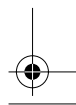
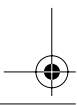

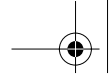

## GUIDE TO FUMIGATION UNDER GAS-PROOF SHEETS

- rolling the polyethylene tubing at the top of the enclosure, around a sand snake and weighting down the roll with one or two more sand snakes.

### **Fumigation of small quantities of grain with phosphine in rural areas**

The above method of fumigating small quantities of grain can be used in rural areas where merchants buy, store, and sell small quantities of grain.

In these situations, where the grain may also be stored inside the plastic enclosures after the fumigation process, a number of simple but important precautions must be observed:

- Make sure that the polyethylene tube is not damaged, because leaking phosphine is:
  - poisonous and harmful to humans
  - will make the fumigation ineffective.
- The fumigation must only be done in a room that is:
  - not used by people as a workroom or a place for sleeping
  - shaded and cool
  - protected from strong winds, but well ventilated.

The system has been extensively tested in Pakistan, where it has been shown that phosphine may be retained inside the enclosure for up to 20 days after a dosage of two tablets is applied.

**Where appropriate personal protective equipment is not available, enclosures treated in this way must not be opened until at least 21 days after the dosage was applied.**



## GUIDE TO FUMIGATION UNDER GAS-PROOF SHEETS

## 8.11 Disposal of spent aluminium-phosphide residues

At the end of the fumigation, after the danger area has been declared safe, all phosphine-generating formulations (aluminium-phosphide tablets, pellets, sachets etc.) used during the fumigation must be collected and disposed of in a safe manner.

This is done because the aluminium phosphide in the formulations breaks down into a powder called 'spent residues'. However, the spent residues still contain between 3–5% of unreacted aluminium phosphide, which is a safety hazard.

The spent residues must be disposed of carefully and safely. Care must be taken when handling the residues to:

- avoid breathing in the dust
- prevent contact with eyes and skin.

To do this, the fumigator must wear a respirator with appropriate filter canister or self-contained breathing apparatus and follow the procedure outlined below.

- Collect the spent residues into a bucket or drum, taking care not to contaminate the fumigated commodity.
- Take the residues outdoors to a safe area.
- Slowly add the spent residues to a drum containing soapy water (use liquid detergent or washing powder for this purpose).
- The liquid must be slowly and gently stirred to completely mix the powder into the water. During this process, the fumigator must stand upwind from the drum, to minimise the possibility of exposure to any phosphine that may be released.
- After any reaction that may occur has ended, the mixture must be disposed of in a 0.5 m deep hole dug in the ground, which is then filled in.



## 9 FUMIGATING WITH METHYL BROMIDE

### 9.1 The requirements for successful fumigation with methyl bromide

Methyl bromide fumigations are carried out to eradicate pests and other unwanted organisms from commodities and storage enclosures, particularly where short exposure periods are required.

They may also be required in certain quarantine situations.

A well-sealed gastight enclosure is required. Methyl bromide may be introduced into the enclosure:

- as a 'hot gas' (the most efficient method)  
OR
- as a liquid that is vaporised inside the enclosure, using methods (for example tee jets) to prevent the liquid making contact with the contents of the enclosure.

Fans, placed inside the enclosure, should be used to ensure that the gas is evenly distributed.

The design of the fumigation enclosure and fumigant application and dispersion system must allow a uniform concentration of methyl bromide to be achieved throughout the enclosure soon after application.

Fumigators must remember that the exposure period is deemed to start from the time that the fumigant is first found to be evenly distributed inside the fumigation enclosure.

The fumigant is vented at the end of the exposure period – usually 24 hours. This must be done so that the concentration of gas inside the enclosure is reduced to, or below, the TLV (which is 5 ppm in many countries) so that the treated commodity can be handled safely.

Although methyl bromide is very commonly used, it is phytotoxic (toxic to plants) and may influence germination capacity, thus

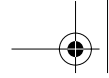

## GUIDE TO FUMIGATION UNDER GAS-PROOF SHEETS

producing **adverse effects in commodities**. For example, methyl bromide can cause taint in both wheat flour and whole grain if applied incorrectly. Liquid methyl bromide, in particular, or excessive or repeated treatments, can taint flour. Methyl bromide may also affect the processing qualities of grain treated with it.

Soybean flour must not be treated with methyl bromide as it is particularly susceptible to persistent taint.

In situations where no information is available about its effects on a particular commodity, it should be tested on a small quantity of that product before the whole stack is fumigated.

### **When to use and when not to use methyl bromide as a fumigant**

Methyl bromide must be used:

- when a treatment must be completed within 4 days or less
- for most quarantine treatments.

Methyl bromide must not be used:

- when there is no trained, qualified, and properly protected fumigation team
- in unsealed enclosures
- on seed required for planting or malting
- on very absorbent materials, such as expeller cake or oilseeds
- in areas immediately adjacent to workspaces or places where people live
- on materials previously fumigated with methyl bromide more than once.

**There may be occasions when methyl bromide must be used to fulfil quarantine or contractual obligations, but where it would not otherwise be the fumigant of choice.**

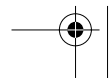
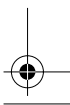
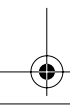
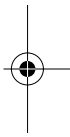
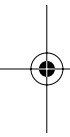

## GUIDE TO FUMIGATION UNDER GAS-PROOF SHEETS

## 9.2 The properties of methyl bromide as a fumigant

The properties of methyl bromide relevant to its use as a fumigant are tabulated below.

Odour	None at low concentrations
Boiling point	3.6°C
Specific gravity as a gas	3.27 (air = 1)
Flammability classification	Non-flammable gas
Method of evolution	As a liquid from cylinders
Chemical reaction	Liquid methyl bromide is a powerful solvent of organic materials and reacts with aluminium and magnesium.

### Odour

At high concentrations (above 80 mg/m<sup>3</sup>), methyl bromide is reported to have a sweet smell.

At low concentrations, methyl bromide has practically no smell or irritating effects.

#### *In fumigation practice this means:*

- *smell cannot be used to warn of the presence of dangerous concentrations of this gas.*

Some preparations of methyl bromide contain 2% chloropicrin (tear gas) or amyl acetate, added as warning agents. However, the smell of these chemicals may be sorbed by the commodity or product being fumigated.

#### *In fumigation practice this means:*

- *fumigators must not rely on the smell or eye irritation (burning) of these chemicals to detect the presence or absence of methyl bromide. Always use a methyl bromide gas detector.*

### Boiling point

Methyl bromide is supplied as a liquid under pressure (2.5 atmospheres at 30°C) in steel cylinders. It boils and vaporises (becomes a gas) at 3.6°C. This process requires a lot of heat.



## GUIDE TO FUMIGATION UNDER GAS-PROOF SHEETS

Understanding of this property of methyl bromide is essential if treatments with this fumigant are to be successful.

### ***In fumigation practice this means:***

- *Heat must be supplied by first passing liquid methyl bromide through a heat exchanger to ensure that it is vaporised before it is delivered into a fumigation enclosure as a gas.*
- *Even if a treatment will be done in the tropics at high ambient temperatures, a vaporiser must be used.*

Not vaporising methyl bromide is one of the main causes for treatment failures with this fumigant.

### **Specific gravity**

Pure methyl bromide gas is 3.27 times heavier than air.

### ***In fumigation practice this means:***

- *Unless gaseous methyl bromide is mixed with the air inside an enclosure, it will tend to settle in a layer at the bottom of the enclosure.*
- *To prevent such layering, gaseous methyl bromide must be:*
  - *delivered into an enclosure at the top of the stack being fumigated*
  - *mixed with the air inside the enclosure using electric fans placed inside the enclosure.*

Not mixing gaseous methyl bromide inside the enclosure is another of the main causes for treatment failures with this fumigant.

### **Flammability**

Methyl bromide is non-flammable in concentrated form. However, when mixed in air in the range between ~10–15% (397–635 g/m<sup>3</sup>) it can be ignited by a high-energy spark. This is well above the normal dosage rates (24–128 g/m<sup>3</sup>) used for fumigation treatments.



## GUIDE TO FUMIGATION UNDER GAS-PROOF SHEETS

### ***In fumigation practice, this means that:***

- *electrical equipment such as fans, electrical switching gear, computers and electronic instruments can be used safely during treatments with this fumigant at normal dosage rates.*

### **Chemical reactions of liquid methyl bromide**

Liquid methyl bromide:

- is a powerful solvent of organic materials and can, for example, remove paint, grease, and other chemicals from machinery, materials and equipment
- can react with chemicals in food grains and other products and may cause bad smells and leave undesirable residues that can damage or destroy such products.

### ***In fumigation practice this means that:***

- *methyl bromide must always be introduced into a fumigation enclosure as a gas, never as a liquid.*

Liquid methyl bromide:

- reacts with aluminium and magnesium, and alloys of these metals, and can cause an explosion.

### ***In fumigation practice, this means that:***

- *these metals must not be used in any equipment to move, convey or apply liquid methyl bromide.*

### **Methyl bromide gas concentrations – conversion table (at 25°C)**

ppm	% (v/v in air)	g/m <sup>3</sup>
5	0.0005	0.02
257	0.026	1.00
1,000	0.100	3.88
4,121	0.412	16.0
8,242	0.824	32.0
12,363	1.236	48.00





## GUIDE TO FUMIGATION UNDER GAS-PROOF SHEETS

### 9.3 Safety rules for fumigators using methyl bromide

Fumigation is a precise operation requiring considerable expertise, and it cannot be undertaken without proper preparation. It is important that management and their fumigators-in-charge understand this, and ensure that proper planning is carried out before a fumigation is done.

1. Are you allowed to fumigate with methyl bromide in your country?
  - Have you been trained to do fumigations with methyl bromide?
  - Do you have the practical experience needed to do a treatment without supervision?
2. Check *all* national and local government rules and regulations telling you *how to do fumigations* in your country. Make sure you understand them.
3. Check *all* national and local government rules and regulations about *use of methyl bromide* in your country. Make sure you understand them.
4. Do you know and understand the dosage rates for methyl bromide recommended for specific commodities in your country?
5. Can you recognise the symptoms of methyl bromide poisoning?
6. Check all equipment before you use it. Make sure it is all in good working condition.
  - Examine all gas-proof sheets by suspending them over a lighted doorway. Repair even the smallest holes that could cause gas leaks, since these leaks could result in human injury or insufficient gas concentration to obtain control of the target pest.
  - For gas cylinders, make sure you have (i) a washer to fit the gas outlet of the cylinder, (ii) the correct fittings to connect the gas-delivery pipe to the cylinder and vaporiser. Check and repair these, if necessary.
  - For cans of methyl bromide, make sure you have an approved (one made by the manufacturer of the cans) applicator for releasing the gas. Check the seals, make sure it is safe to use, and repair it, if necessary, before use.
  - Make sure you have enough methyl bromide to do the treatment.



## GUIDE TO FUMIGATION UNDER GAS-PROOF SHEETS

- Make sure enough sand snakes are available for the job. There must be sufficient to go around the enclosure twice.
  - Make sure a fully equipped tool kit is available.
7. Inspect the place where the fumigation will be done.
- Is it sheltered from strong wind? If not, can it be moved and rebuilt?
  - Is the stack built on a gas-proof floor?
  - Are you sure there are no drains under the stack?
  - Can the enclosure be sealed properly?
  - Has the stack been built around a pillar? If so, rebuild it with the pillar outside.
  - Is there enough space between the stack and the walls?
  - **Are there any connecting godowns?**
  - **Identify all houses around the danger area where people live. Will the people who live in them be safe during the exposure period?**
  - **Identify any items that could be damaged by methyl bromide and make sure they are removed before the fumigation starts.**
8. If it is possible to do a fumigation?
- Is there enough time to do the fumigation properly?
  - Can the fumigation be done at a time when workers are not present?
  - Can the enclosure be aerated at a time when workers are not present?
  - Is it possible to close off the danger area?
  - Is it possible to safely aerate the enclosure at the end of the exposure period?
  - Is electricity available to drive fans to distribute the gas inside the enclosure and aerate it at the end of the exposure period? If not, a portable generator will be required.
9. Emergency action
- Look for and identify all *safe ways to get out of the fumigation area* in an emergency.



## GUIDE TO FUMIGATION UNDER GAS-PROOF SHEETS

- Identify emergency doors, connecting godowns, and a water supply,
  - Identify the nearest telephone, the nearest hospital, the nearest doctor, and the nearest fire brigade.
  - Find the quickest way to the nearest hospital.
  - Make sure two trained persons are present at all times during the fumigation.
- 10. Develop a fumigation plan**
- Tell all fumigation staff:
    - how the fumigation will be done
    - how to leave the fumigation area *safely* in case of emergency
    - what to do if any person breathes in methyl bromide gas
    - what to do if any person makes contact with liquid or gaseous methyl bromide, e.g. if a gas hose breaks/bursts/ruptures
    - who will monitor gas concentrations in the workspace.
  - All people involved with the fumigation must be shown around the fumigation site. If there is a safer way of performing the fumigation, revise the fumigation plan.
- 11. Make sure all fumigation staff:**
- know what first aid action to take in case anyone is injured
  - are equipped with, and know how to use, personal-protection equipment appropriate for fumigation with methyl bromide (self contained breathing apparatus, gas masks)
  - understand that *gloves must not be worn during fumigations with methyl bromide* because they increase the risk of skin contact with liquid methyl bromide (see Section 9.5).
- 12. Be sure, before a fumigation is started,** that the nearest doctor (or hospital) has instructions on how to treat injuries caused by methyl bromide.
- 13. Where necessary, the fumigator-in-charge must make sure that** all national and local government agencies (for example, the police, the fire brigade, the nearest hospital etc.), that might be involved with the fumigation treatment, have been told where and when the fumigation treatment will be done.

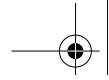

## GUIDE TO FUMIGATION UNDER GAS-PROOF SHEETS

---

14. Check weather conditions before fumigation
  - If it is possible that wind will damage fumigation sheets, delay the fumigation until the treatment can be done safely, or take other precautions.
15. Fumigators must not consume alcohol less than 24 hours before the start of a fumigation.
16. Warning signs
  - Always put warning signs (in appropriate languages) around the danger area at a fumigation site. Include an emergency telephone contact number.
  - The signs must be at places where people are most likely to see them.
  - Guards must be used if required by government (or other) regulation.
17. Monitoring
  - Always use leak-detection equipment to check that the workspace is safe and the enclosure is well-sealed.
18. **Do not** eat, drink or smoke at any time when doing a fumigation with methyl bromide.
19. Spills
  - If methyl bromide is spilled or sprayed on a person:
    - remove clothing, watches, rings, shoes, and anything else that may hold the fumigant against the body
    - rinse the area exposed to the liquid fumigant with water
    - leave the skin uncovered to help volatilise any remaining liquid
    - do not reuse contaminated clothing before it has been washed.
20. Repeated small exposures to methyl bromide can be dangerous. Always plan ways to *minimise unprotected exposure to methyl bromide*.
21. If anyone gets sick during fumigation, with symptoms of, or similar to, methyl bromide poisoning, do not take chances. Take the person to a doctor and let the doctor decide the cause of the illness (see Section 9.5).

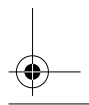
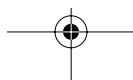
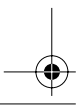
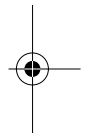
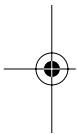



## GUIDE TO FUMIGATION UNDER GAS-PROOF SHEETS

### 22. Clothing

- After a fumigation, fumigators must wash thoroughly and change their clothes immediately.
- Dirty clothing worn by fumigators must be washed separately from other clothes, especially infants' clothes.

### 23. Aeration

- Aeration must be done in stages to avoid sudden release of large amounts of fumigant.
- For methyl bromide fumigation, desorption may take longer than 24 hours, and the fumigated enclosure must be kept under continuous surveillance and ventilation. The danger areas must be rechecked to ensure the area is safe.

### 24. Clearance

- Clearance must not be issued after aeration until monitoring instruments show that gas concentrations have fallen to, or are below, the TLV set for methyl bromide in your country.

### 25. The fumigator-in-charge must make sure that all national and local government agencies (for example, the police, the fire brigade, the nearest hospital etc.), that might be involved with the fumigation treatment, have been notified that the fumigation has ended.

### 26. Warning signs

- After clearance has been given at the end of the aeration period, *remove all warning signs*.
- If signs are not removed, people will ignore them during the next fumigation.

### 27. Promptly return all empty methyl bromide cylinders to the supplier.

**Never give or sell fumigants to untrained persons.**

In **best fumigation practice**, the whole fumigation process is conducted using safe operating practices in accordance with OH&S, environmental, other regulatory requirements, and equipment and chemical manufacturers' specifications/instructions.

## GUIDE TO FUMIGATION UNDER GAS-PROOF SHEETS

## 9.4 Personal-protection equipment for methyl bromide fumigation

Fumigators must always comply with national and local government regulations covering personal-protection equipment required during fumigation treatments with methyl bromide.

Where no such regulations exist, the recommendations below provide a guide for essential items of personal-protection equipment.

### Respiratory protection

Fumigators and other persons at risk from inhaling excessive quantities of methyl bromide must be provided with either a full-face canister respirator or an open-circuit, self-contained breathing apparatus with full face mask. Respiratory protection must be worn whenever tests of the atmosphere reveal concentrations of the gas greater than the hygienic standard (currently 5 ppm in many countries).

Masks and canisters must be issued on a personal basis, and a register of use maintained by the fumigator-in-charge.

Canisters must never be worn for entry into the closed fumigation enclosure itself. If this is ever necessary, self-contained breathing apparatus must be worn.

#### *Canister respirators*



Canister respirators must be fitted with a canister designed for protection against methyl bromide, as recommended by national and local government regulations. Each time a respirator of this type is put on, the facial fit must be tested by closing the inlet to the canister with



**GUIDE TO FUMIGATION UNDER GAS-PROOF SHEETS**

the palm of the hand and inhaling deeply; the vacuum so created must cause the face-piece to adhere to the face for about 15 seconds.

With this type of respirator, it is essential that the canister be used within its stated shelf life. The respirator canister must always be replaced before either its shelf life has expired or the recommended usage time has been reached. The expiry date of a canister may easily be calculated since each is marked with the date of manufacture and its shelf life.

Canisters must be stored in a cool, dry, well-ventilated place away from contamination by any fumigants. The following precautions must always be observed:

- When the canister is attached to the respirator face-piece after the top seal is removed, record the date. This is best done by writing the date on a small adhesive label, which must be affixed to the canister. This label must also be used as a 'log' to record exposure of the canister to the fumigant.

Date attached to mask <i>01/02/03</i>		Time available (initially 120 minutes)
Date used	Time used	

- Before using the respirator, remove the cap and the seal over the air inlet valve of the canister. Again at this time, mark the date on the 'log' label. Once this seal is removed, even if there is no exposure to fumigant, replace the canister after 6 months have elapsed.



### GUIDE TO FUMIGATION UNDER GAS-PROOF SHEETS

Date attached to mask <i>01/02/03</i>		Time available (initially 120 minutes)
Date used	Time used	
<i>01/02/03</i>	<i>30</i>	<i>90</i>
<i>02/02/03</i>	<i>45</i>	<i>45</i>
<i>05/02/03</i>	<i>40</i>	<i>5</i>

- After any fumigation in which there has been (i) prolonged exposure to low concentrations of the fumigant, or (ii) accidental exposure to high concentrations, immediately discard the canister. As a guide, 1 hour of wearing is the usual period after which a canister must be discarded. This could be extended to 2 hours, but only when exposure is minimal. Allow a wide margin of safety in estimating exposure times, as canisters cost little in terms of health of the individual. If there is any doubt about the exposure life of the canister, discard it.
- Canisters must be resealed with the original top and bottom seals between uses.
- When canisters are discarded, they must be made unusable by damaging the inlet port. They must then be disposed of under conditions which will prevent them from being picked up and used again.
- Canisters that show any sign of external damage must be considered worthless, and must be discarded. A severe blow on the metal covering may cause displacement of the contents, permitting contaminated air to pass through to the wearer.
- Immersion of the canister in water makes it useless. To prevent water entering the canister through the face-piece, always disconnect the hose and/or canister when cleaning or disinfecting the face-piece.

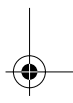
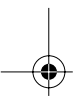
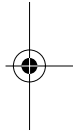
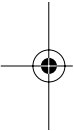



## GUIDE TO FUMIGATION UNDER GAS-PROOF SHEETS

### *Self-contained breathing apparatus*



Self-contained breathing apparatus must be available at all times when fumigating with methyl bromide. The facial fit of this type of apparatus may be tested in the same way used for canister respirators, except that the cylinder valve is closed before deep inhalation.

**Persons who have to wear full-face respiratory-protection equipment during a fumigation treatment must be clean shaven, to ensure the best possible gastight fitting to the face.**

**Persons who need to wear prescription glasses while using a respirator must obtain special, armless lens frames that are made specifically to fit inside the visors of such equipment.**



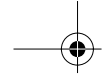

## GUIDE TO FUMIGATION UNDER GAS-PROOF SHEETS

### Skin protection

A loose-fitting, cotton boiler suit (overalls), with full arms, must be worn by all persons engaged in a methyl bromide fumigation. Gloves must not be worn and lightweight shoes are better than boots (see Section 9.3). Any protective clothing, including footwear, subjected to liquid methyl bromide must be discarded immediately after allowing it to air in a safe, well-ventilated place.

In **best fumigation practice**, suitable personal protective equipment is selected and used in accordance with OH&S, environmental, other regulatory requirements, and equipment and chemical manufacturers' specifications/instructions.

## 9.5 Methyl bromide health-hazard information

This section details the signs and symptoms of methyl bromide poisoning.

### Routes of exposure

Methyl bromide can affect the body if it:

- is inhaled
- comes in contact with the eyes
- comes in contact with the skin
- is swallowed.

**The signs of poisoning by methyl bromide are often delayed and do not become apparent until 8–24 hours after exposure, depending on the severity of the exposure.**

Exposure to methyl bromide may cause one or more of the following symptoms:

- dizziness
- headache
- blurred vision
- a general tiredness in body or mind





## GUIDE TO FUMIGATION UNDER GAS-PROOF SHEETS

- staggering gait (behaving like a drunk person)
- slurred speech
- nausea and vomiting
- loss of appetite,
- abdominal pains.

In cases of exposure to methyl bromide, the person affected must be:

- immediately taken into fresh air
- kept under observation for at least two (2) days for possible evidence of poisoning.

### First aid

#### *Methyl bromide has been swallowed*

Rinse mouth with water. **Do not induce vomiting.** Make the victim drink 250–300 mL of water. If breathing stops, begin expired air resuscitation. Obtain medical attention immediately. If pulse is absent, begin external heart compression. Get urgent medical attention.

#### *Methyl bromide in eye or eyes*

Gently trickle water in the affected eye(s) for 20 minutes. Keep the eyelids apart while doing this. Get urgent medical attention.

#### *Methyl bromide has come into contact with skin*

Prolonged contact with methyl bromide has a blistering effect on the skin. Remove soiled clothes immediately. Remove boots and jewellery (rings). Wash skin thoroughly with soap and water.

#### *Methyl bromide has been inhaled*

Take the victim out into fresh air. Keep them quiet and warm. If breathing stops, begin expired air resuscitation. If pulse is absent, begin external heart compression. Get urgent medical attention.

### Threshold limit value (TLV)

The TLV (see Section 2) for methyl bromide has been set, in many countries, at:

**5.0 ppm (0.02 g/m<sup>3</sup> or 19.4 mg/m<sup>3</sup>).**

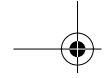

## GUIDE TO FUMIGATION UNDER GAS-PROOF SHEETS

**Fumigators must be aware that concentrations of methyl bromide between 0 and 10 ppm cannot be accurately detected by halide leak detector lamps. Because of this, these instruments must not be used for occupational health and safety purposes.**

### 9.6 Effect of methyl bromide on the commodity being fumigated

Some products must not be fumigated with methyl bromide. This applies especially to finely ground products and products containing oils and fats. Such materials can absorb large quantities of methyl bromide and in some cases this can be the cause of:

- tainting (bad smells or tastes)
- excessive bromide residues.

This may cause the fumigated product to become unsuitable for its intended use. In addition, excessive sorption of methyl bromide can cause safety risks.

If there is any worry that a product may be harmed by methyl bromide, the owner and/or the fumigator must get expert advice on the matter.

If no experts are available, a test can be done with a small sample of the product *before treating the whole consignment*.

Listed on the next page are products and commodities with which problems can occur when they are fumigated with methyl bromide. Note that the list is **not comprehensive**.

In **best fumigation practice**, the whole fumigation process is conducted using safe operating practices in accordance with OH&S, environmental, other regulatory requirements, and equipment and chemical manufacturers' specifications/instructions.





## GUIDE TO FUMIGATION UNDER GAS-PROOF SHEETS

### Commodities likely to be affected by methyl bromide

#### Foodstuffs

1. Butter, lard and fats
2. Iodised salt stabilised with sodium hyposulfite
3. Full fat soybean flour, whole wheat flour, other high protein flours and baking powders
4. Nuts with high oil content
5. Certain baking sodas, cattle licks (i.e. salt blocks), and other foodstuffs containing reactive sulfur compounds
6. Bone meal

Note: Never exceed the recommended dosage or exposure periods for food or foodstuff commodities. Before repeated fumigation, have the food commodity analysed for inorganic bromide residues.

#### Paper

1. Silver polishing papers
2. Certain writing and other papers cured by sulfide processes
3. Photographic prints and blue-prints stored in quantity
4. 'Carbonless' carbon paper
5. Blueprint papers

**Leather goods** (particularly kid or other leather goods tanned with sulfur processes)

**Woollens** Extreme caution must be used in the fumigation of Angora woollens. Some adverse effects have been noted on woollen socks, sweaters, shawls and yarn.

**Viscose rayon** Those rayons processed or manufactured by a process in which carbon bisulfide is used

**Photographic chemicals** (except camera film or X-ray film)

#### Rubber goods

1. Sponge rubber
2. Foam rubber (as used in rug padding, pillows, cushions, mattresses, and some car seals)
3. Rubber stamps and other similar forms of reclaimed rubber

#### Vinyl

**Feathers** (especially in feather pillows)

**Charcoal**, cinder blocks and activated carbon

**Oil artworks**

**Sulfur-based paint**

**Furs**

**Rug padding** (foam rubber, felts etc.)

**Horsehair articles**

**Cellophane**

**Polystyrene packaging and containers**



## GUIDE TO FUMIGATION UNDER GAS-PROOF SHEETS

### 9.7 Methyl bromide dosage rates

#### Choosing the correct dosage

To choose the correct dosage for the product that you want to fumigate, look for and read the manufacturer's label, which is attached to the container of methyl bromide you are using. This label contains specific information that tells you:

- how the product should be applied
- what products it can be used for
- how much to apply for each product or group of products
- the length of the exposure period for each product or group of products
- the length of the withholding period.

The dosages on the label are presented as an amount of fumigant gas per unit of volume of space/enclosure, usually given as grams per cubic metre, which is abbreviated as g/m<sup>3</sup>.

Remember that dosage recommendations consist of two parts: (i) the amount of methyl bromide that must be put into the fumigation enclosure, and (ii) the length of the exposure period.

Read the label carefully then carefully select and calculate the dosage in accordance with the instructions on the label.

If you have any difficulty understanding the label, or if a product is not listed on the label, always seek the advice of the relevant national agricultural chemicals registration agency – before you start the fumigation.

In future, use of methyl bromide will be restricted largely to quarantine and pre-shipment treatments. The dosages required for such treatments are not usually published on the label.

When fumigations are done for quarantine purposes, it is important that fumigators make sure that the dosages they use for such treatments comply with the requirements of the relevant national and international regulatory agencies.



## GUIDE TO FUMIGATION UNDER GAS-PROOF SHEETS

In **best fumigation practice**, the dosage is selected and calculated accurately in accordance with:

- the manufacturer's specifications/instructions
- the client's requirements
- OH&S, environmental and other regulatory requirements.

### 9.8 Introducing methyl bromide into an enclosure

Methyl bromide is supplied to fumigators as a liquid under pressure packed in:

- cylinders typically containing 50–100 kg liquid methyl bromide
- tins (or cans) containing 0.5–1.0 kg liquid methyl bromide.

Liquid methyl bromide can taint and/or damage certain products if it makes direct contact with them. Examples of such products are:

- flour (taint)
- aluminium (chemical reaction, explosion and breakdown)
- foodstuffs and other products (accumulation of residues).

To reduce the possibility of this happening, liquid methyl bromide must be vaporised for use as a fumigant. There are two places where this can be done:

- outside the enclosure
- inside the enclosure.

#### Vaporising methyl bromide outside the enclosure

In **best fumigation practice**, this is the preferred method for delivering methyl bromide into an enclosure, because problems of gross contamination, taint, and residues are much reduced.

The process involves passing liquid methyl bromide – from a cylinder – through a **vaporiser** that consists of a copper coil (a heat exchanger) submerged in a container of heated water.

The gaseous methyl bromide coming out of the vaporiser is then delivered into the enclosure through a **system of branched pipes**. Fans must always be placed inside the enclosure to make sure the gas is evenly distributed.

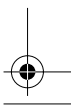
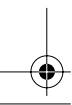
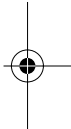
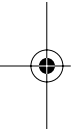

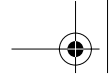

## GUIDE TO FUMIGATION UNDER GAS-PROOF SHEETS

A flow rate of methyl bromide–air mixture at 1.5 m<sup>3</sup>/hour/tonne (for cereal grains) is adequate to establish uniform distribution of the gas within approximately one hour.

Compared with vaporising methyl bromide inside the enclosure, this method has a number of advantages including:

- fewer gas-distribution pipes are needed
- there is more rapid dispersal of gas
- the time for the gas to reach equilibrium is shorter.

### Vaporising methyl bromide inside the enclosure

This process involves delivering liquid methyl bromide into the enclosure through **a system of branched pipes**.

The liquid is vaporised when it exits from the ends of the pipes. There are two ways to do this:

1. Releasing the liquid into the enclosure through jets (for example, Bray jets, gas welding jets) fitted to the ends of the branched delivery pipes.

The jets break the liquid methyl bromide into a fine spray, so it vaporises by taking heat from the air.

Care must be taken to make sure that the spray of liquid methyl bromide does not make contact with the goods to be fumigated. This is done by releasing the spray into a 'trench' made in the top of the stack.

The trenches provide an air space in which liquid methyl bromide can vaporise as it emerges from the delivery pipes.

Fans must always be placed inside the enclosure to make sure the gas is evenly distributed.

2. Releasing the liquid into the enclosure through the ends of the delivery pipes into metal buckets or (less suitably) metal 'pans'.

This method allows the liquid to vaporise in the metal buckets or pans, which are placed in the 'trench' made in the top of the stack.

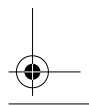
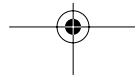
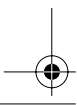
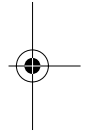
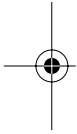





## GUIDE TO FUMIGATION UNDER GAS-PROOF SHEETS

---

Vaporisation by this method is slower than using jets – even if the sheets are tented above the top surface of the stack.

To prevent spillage when ‘pans’ are used, it is advisable to cover the ends of the delivery pipes with old, empty bags. If this is done, the bags must not be used again for any other purpose.

Fans must always be placed inside the enclosure to make sure the gas is evenly distributed.

**Note 1.** When this method is used, care must be taken to make sure that (i) the ends of the delivery pipes are placed inside the buckets or pans, and (ii) the containers are deep enough to hold all the liquid that is likely to come out of the pipe.

**Note 2.** Do not use plastic buckets or pans. Liquid methyl bromide causes plastic materials (including fumigation sheets) to become brittle and crack, which can allow the liquid to make contact with the product being fumigated.

### *Disadvantages of vaporising methyl bromide inside enclosures*

The likelihood that liquid methyl bromide will make contact with the product being fumigated when it is vaporised inside the enclosure cannot be ignored. This can occur if:

- trenches or pits are not made in the top of the stack
- jets are ‘blown’ off the ends of delivery pipes
- badly joined pipes break apart
- delivery pipes shake and ‘splutter’ as liquid vaporises inside them
- liquid methyl bromide overflows from pans.

In addition, plastic fumigation sheets tend to harden and break when liquid methyl bromide comes into contact with them.

## 9.9 Fumigation temperatures

Under normal circumstances, methyl bromide must not be used at temperatures below 10°C. This is because:

- it becomes less effective against pests
- sorption of the gas increases.

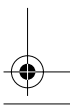
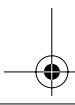
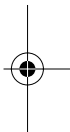
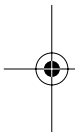



## GUIDE TO FUMIGATION UNDER GAS-PROOF SHEETS

Perishable commodities (including living plants, cut flowers, fresh fruit and vegetables and some seeds) must not be fumigated below 10°C.

Because of the likelihood of damage, living plants must not be fumigated at temperatures above 30°C.

At the end of the fumigation treatment, the increased sorption of methyl bromide requires long aeration periods, because the gas is very difficult to remove from the commodity at low temperatures.

If aeration is not done properly, this can create a risk to safety.

### 9.10 Equipment specifically required for methyl bromide fumigation

The following should be provided:

- warning signs and ropes or tapes (or other materials) to indicate and prevent public access to the danger area
- self-contained breathing equipment with extra air tanks, or gas masks with canisters for methyl bromide
- gas-detection equipment for monitoring workspace gas levels
- gas-proof fumigation sheets
- materials for making temporary repairs to sheets; adhesive tape, patches, glue compatible with plastic sheeting used (e.g. PVC solvent glue for PVC sheets)
- clips and thin narrow strips of wood for holding together rolled or joined sheets
- sand snakes
- ladder
- rope for lifting fumigation sheets and stopping sheets from flapping loose in wind
- measuring tape
- gas in cylinders (or cans)
- calibrated gas-dispensing system for use with gas from cylinders
- platform scales if a gas dispenser is not used
- vaporisers complete with heat source



## GUIDE TO FUMIGATION UNDER GAS-PROOF SHEETS

- correct (manufacturer's) equipment for dispensing gas from cans
- high-pressure-rated gas-delivery pipe for use from gas cylinder to vaporiser
- high-pressure-rated gas-delivery pipe for use from vaporiser to enclosure
- fans for gas distribution inside the enclosure, and for aerating the enclosure after fumigation
- trolley for carrying gas cylinders, sand snakes and other heavy equipment
- narrow-bore tubing for sampling gas concentrations inside the enclosure
- equipment for monitoring gas concentrations inside the enclosure
- fumigation record sheets
- clearance certificates.

### Vaporisers for methyl bromide

Vaporisers can be made in several ways. The three photographs below show a vaporiser that is used by fumigators in Australia.

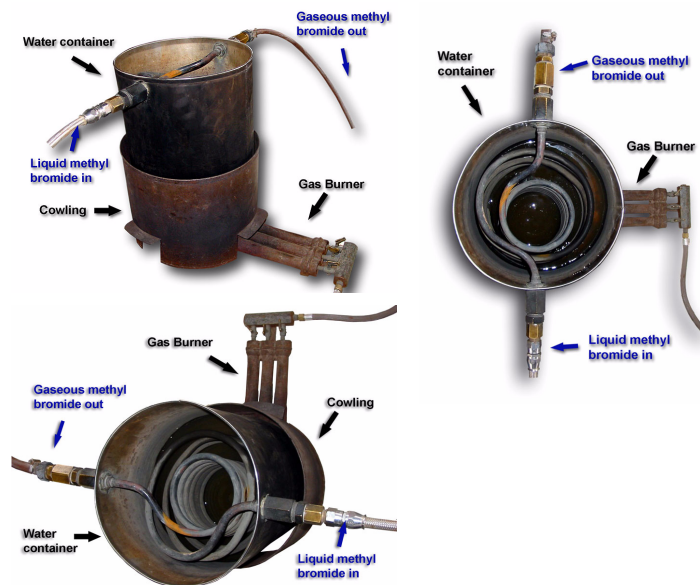

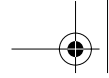

## GUIDE TO FUMIGATION UNDER GAS-PROOF SHEETS

This vaporiser consists of four parts:

1. a large water container
2. a coil of copper piping (a heat exchanger)
3. a gas (LPG) burner that provides heat
4. a cowl (or cover) placed around the gas burner.

### *The water container and heat exchanger*

This should be made from stainless steel. Inside the container is the heat exchanger, which is a double coil of copper pipe. As liquid methyl bromide passes through this pipe, it takes heat from the water and is vaporised, so that it is delivered into the enclosure as a gas.

To make sure that any warning agent (chloropicrin) included in the methyl bromide is fully vaporised, the temperature of the water must not be allowed to fall below 65°C.

Handles should be fitted to the top of the container to make it easy to carry. The handles should be large enough to allow a length of bamboo or other suitably sized piece of timber to pass through them. This will allow two people to safely carry the vaporiser when it is filled with water.

### *The gas burner*

A burner of the type used for cooking large quantities of food is ideal. It must have two or three rings, so that it can very rapidly boil the water in the container and hold it above 65°C while liquid methyl bromide passes through the heat exchanger.

To control the amount of heat produced, each burner ring should have its own gas supply with a separate tap.

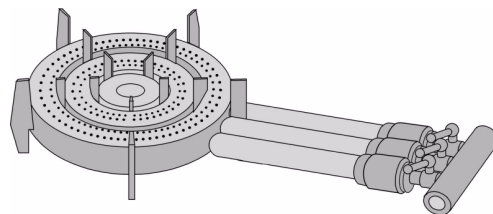

TYPICAL 3 RING GAS BURNER

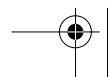

**GUIDE TO FUMIGATION UNDER GAS-PROOF SHEETS**

*The cowling*

A cowling is needed to direct the heat produced by the burner up and around the sides of the water container, and to protect the flames from sudden gusts of wind.

**Technical drawings**

To allow fumigators to construct a vaporiser, the following drawings provide the sizes of the parts of the vaporiser shown in the photographs on page 133.

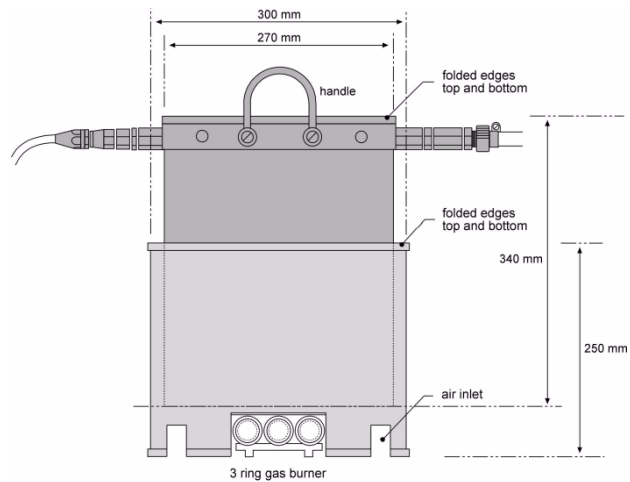

**FRONT VIEW**

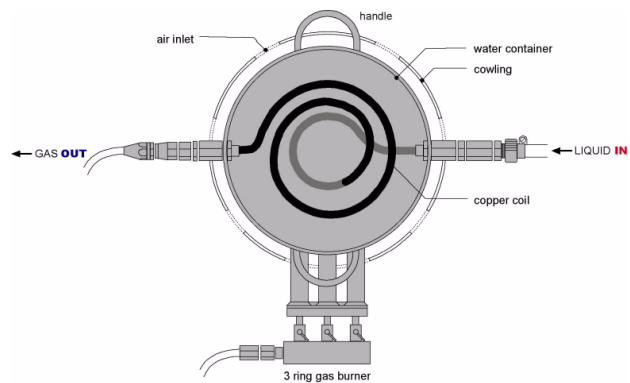

**PLAN VIEW**

## GUIDE TO FUMIGATION UNDER GAS-PROOF SHEETS

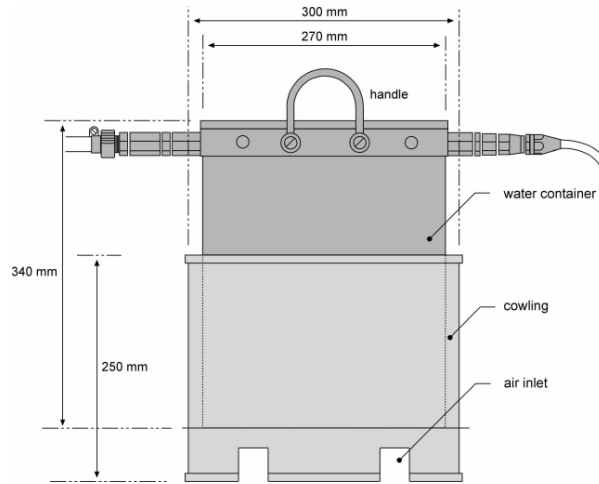

BACK VIEW

To prevent any liquid methyl bromide passing through the heat exchanger into the enclosure, fumigators must always make sure that water continues to boil, by carefully regulating:

- the amount of heat applied to the water
- the speed at which liquid methyl bromide is allowed to flow into the vaporiser.

### Materials required to make the vaporiser that is illustrated

- **Stainless steel sheet 1.6 mm thick.** Stainless steel should be used for the water container and cowling because mild steel sheet rusts very rapidly.
- **12 metres of 12 mm outside-diameter copper pipe,** for the heat exchanger, which has a heat-transfer surface of 0.45 m<sup>2</sup>. The pipe should be twisted into a double coil for this purpose.



## GUIDE TO FUMIGATION UNDER GAS-PROOF SHEETS

The whole coil must provide a heat-transfer surface of about 0.1 square metres for each kilogram of fumigant to be vaporised per minute.

- **A three-ring gas burner**
- **Brass and copper fittings** as required to attach the heat exchanger to the water container, and so that connections can be made to the cylinder of liquid methyl bromide at one end, and to the pipe used to deliver gas into the enclosure.
- **A reliable dial thermometer** may be fitted to the water container to measure the temperature of the water.

### 9.11 Methyl bromide supply system

#### Distributing fumigant within the enclosure

Methyl bromide may be delivered into an enclosure as a gas or as a liquid. In both cases, a system of pipes is required.

Fumigators must remember that methyl bromide is 3.27 times heavier than air. This means that, unless action is taken to mix it with the air inside the enclosure, it will tend to accumulate in high concentrations at floor level.

To prevent this happening and make sure it disperses properly throughout the fumigation enclosure, fumigators must do **three things**:

1. deliver the methyl bromide into the top of the enclosure, on top of the product to be fumigated
2. 'balance' the pipes used to distribute the methyl bromide inside the enclosure
3. use fans to mix the methyl bromide with the air inside the fumigation enclosure.

#### *Top of the enclosure*

Delivering methyl bromide at the top of the enclosure means that the gas will fall to the floor and create air currents that help mix the gas.

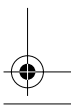
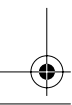
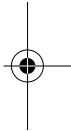



### GUIDE TO FUMIGATION UNDER GAS-PROOF SHEETS

#### *Balancing the delivery pipes*

The pipes used to distribute the gas inside the enclosure are 'balanced' by making sure that every 'branch' (see illustration below) is the same length and diameter.

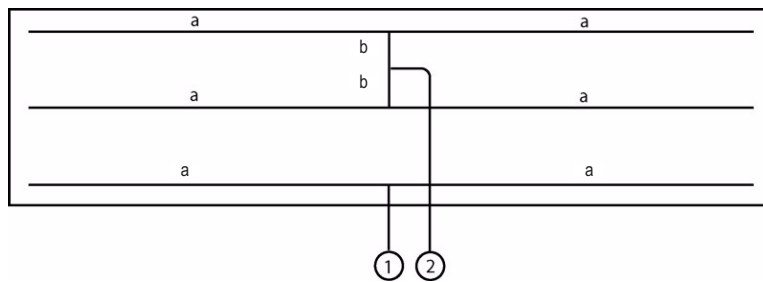

This stack requires a dosage of 30 kg of methyl bromide

- 20 kg must be introduced through pipe # 2, where all branching is the same length
  - 10 kg must be introduced through pipe #1, which is not the same length as pipe #2.
- Branches labelled with the same letter are of equal length.

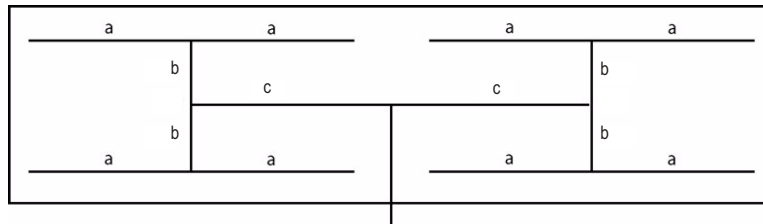

This stack requires a dosage of 30 kg of methyl bromide. The full dosage can be applied through a single pipe because the whole gas delivery system is balanced with all branching of the same length.

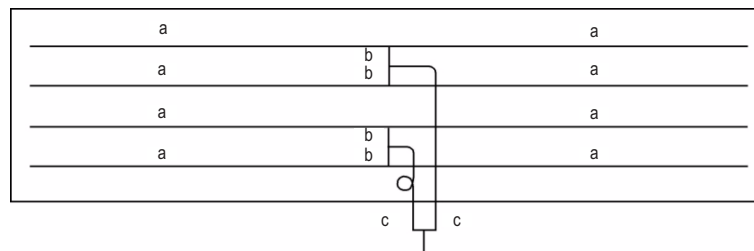

This stack requires a dosage of 30 kg of methyl bromide. The full dosage can be applied through a single pipe because the whole gas delivery system is balanced with all branching of the same length.





## GUIDE TO FUMIGATION UNDER GAS-PROOF SHEETS

If this is done properly, it is possible to deliver all of the methyl bromide gas into the enclosure through the entire system at once, because approximately the same amount of gas comes out of the end of every 'branch' and helps to get an even distribution of gas inside the enclosure.

**Where it is not possible to balance the system, several unbranched supply lines can be used to deliver the gas to the top of the enclosure.** However, the fumigator must make sure that the right amount of gas is delivered through each supply line in turn, until all of the required dosage has been put into the enclosure.

For example, with an enclosure that requires a dosage of  $n$  kg of methyl bromide, through three delivery pipes, the amount required is  $n \div 3$  kg per delivery pipe.

### *Fans*

Fans should be used to rapidly mix the gas with the air inside the enclosure. For example, axial fans with minimum capacity of 13 cubic metres of air per minute provide the sort of air circulation required in a fumigation enclosure holding about 500 tonnes of cereal.

The number of fans needed depends on the size of the enclosure. For example, only one axial fan is needed when shipping containers are fumigated under gas-proof sheets.

However, if more than one shipping container is being fumigated under a single enclosure, there must be a fan for each container so the gas mixes and diffuses properly.

Where large enclosures are fumigated, two or more fans must be used. These must be placed at opposite ends of the stack to ensure good mixing.

Care must be taken if high-speed, high-volume fans are used for recirculation at a rate of  $1.5 \text{ m}^3/\text{hour/t}$  for cereals. They must not be allowed to run for longer than 15–30 minutes after the introduction of the gas. This is because they may force the fumigant gas out of the enclosure.

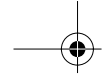

## GUIDE TO FUMIGATION UNDER GAS-PROOF SHEETS

The fumigator-in-charge must **monitor gas concentrations** inside the enclosure after it has been introduced.

### 9.12 Specifications for delivery pipes and their layout

To be sure that the gaseous methyl bromide is evenly distributed inside the enclosure, the delivery pipes must be put together in a way that allows approximately equal amounts of methyl bromide to be delivered from a number of outlets uniformly spaced over the top of the stack.

This is done by making sure that:

- all pipes used have the same bore (internal diameter)
- all branches of the system are put together so that they are the same length
- there is an air space at the end of every outlet: a minimum of 0.5 cubic metres is suggested.

When methyl bromide is delivered into the enclosure as gas:

- the pipes used must have a wide bore, i.e. 12 mm or more
- there must be at least one gas outlet for every 50 square metres of the top surface of the stack.

When methyl bromide is delivered into the enclosure as a liquid:

- the pipes used must have thick walls (approx. 12.7 mm outside diameter) with a narrow bore (6.35 mm) to withstand the pressure of the liquid. Black Alkathene (a form of polyethylene) is commonly used for this purpose
- because the liquid must be vaporised, more outlets are required. There must be at least one outlet for every 10 square metres of the top surface of the stack
- the outlets must be located at intervals of not more than 4 metres along the ends of the delivery and distribution pipes
- even if the liquid is vaporised by releasing it through jets, a drip tray must be placed under each outlet to prevent the liquid making direct contact with the product being fumigated
- if the liquid is not released through jets, it is essential to place a drip or evaporation tray under every outlet





## GUIDE TO FUMIGATION UNDER GAS-PROOF SHEETS

- the buckets or trays must be deep enough to hold all liquid methyl bromide likely to emerge from the delivery pipe to prevent it making direct contact with the product being fumigated
- do not use aluminium or plastic buckets or trays. Aluminium reacts with liquid methyl bromide, and plastic becomes brittle and breaks very easily when it comes into contact with liquid methyl bromide.

**Always use high-pressure pipes approved for use with liquid or gaseous methyl bromide.**  
**Never use garden hoses or pipes for fumigation.**

### Trenching or channelling at the top of stacks

Whenever possible, the system of pipes that delivers methyl bromide into the enclosure should end in one or more 'trenches' at the top of the stack.

Making trenches at the top of a stack is not difficult if the product to be fumigated is stacked in bags, e.g. grains, milled products, and other commodities.

The purpose of the trenches is to:

- provide an air space at the top of the stack where liquid methyl bromide can vaporise as it emerges from the delivery pipes
- ensure the gas is evenly distributed inside the enclosure.

As a general rule, one trench is required for every 5 metres of width across the upper surface of a stack.

The trenches should be:

- built along the length of the stack
- inset from the sides (length and breadth) of the stack by 2 metres
- 1 metre wide and 1 metre deep
- separated by no more than 4 metres.

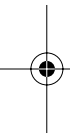
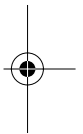



## GUIDE TO FUMIGATION UNDER GAS-PROOF SHEETS

To calculate the number of trenches required, the following examples can be used as a guide:

- for a stack 10 metres wide, 2 trenches are required
- for a stack 15 metres wide, 3 trenches are required
- for stacks between 10 and 15 metres wide, 3 trenches are also required.

In fumigation practice, trenches are made by removing a double row, two bags deep of 80 kg bags which are stacked on either side of the trench, two high. This results in a trench that is four bags deep and two bags wide.

When the stack is enclosed, the fumigation sheets are raised off the top of the stack by the bags placed one on top of the other bags along the side of the trench. This 'tenting' allows the gas to circulate more freely than when the sheets lie flat on the top surface of the stack, and helps the gas mix more rapidly with the air inside the enclosure.

Where stacks are built with bags of a smaller capacity, the number of bags to be removed must be adjusted to obtain the required trench depth and width.

In **best fumigation practice**, the enclosure is treated using all appropriate equipment, fumigants, and fumigation methods in accordance with OH&S, environmental and other regulatory requirements.

### 9.13 Monitoring for methyl bromide

Monitoring methyl bromide gas concentrations allows the fumigator to find out:

- if enough gas has been added to the enclosure
- when the gas inside the fumigation enclosure is evenly distributed (in equilibrium) and to start timing the exposure period
- if the gas is leaking out of the enclosure
- if it is necessary to top-up the dosage to make sure that the fumigation treatment will be successful
- find out if the target endpoint concentration has been reached.





## GUIDE TO FUMIGATION UNDER GAS-PROOF SHEETS

Carbon dioxide (CO<sub>2</sub>) may sometimes:

- be used to pressurise cylinders containing liquid methyl bromide and assist in distributing the fumigant inside the enclosure
- accumulate due to insect metabolism or high-moisture commodity. This is particularly so after the heavily infested stack or moist commodity is covered with the plastic sheeting and not fumigated immediately.

Fumigators must be aware that:

- high levels of carbon dioxide can cause incorrect readings in some instruments commonly used to measure methyl bromide concentrations
- volatiles released by commodities such as cocoa, rice bran, oilcakes and dried fish, and methyl chloride formed during the fumigation period, give erroneous readings for the fumigant when thermal conductivity meters are used for monitoring methyl bromide.

### 9.14 Fumigation of loaded freight containers with methyl bromide

Freight containers may be new or appear to be in good condition, but this does not guarantee that they are gastight. They must therefore be fumigated under gas-proof sheets, unless shown to be sufficiently gastight according to the pressure-test described in Section 7.14.

When freight containers are fumigated with methyl bromide remember to:

- fully open at least one door
- put gas monitoring pipes in place
  - on top of the cargo as far back as possible
  - in the middle of the cargo
  - on the floor of the container
- place the gas-introduction hose beneath the cargo and well away from the gas-monitoring (sampling) pipe



## GUIDE TO FUMIGATION UNDER GAS-PROOF SHEETS

- use a fan to circulate the gas inside the container after the gas has been introduced
- use a fan to ensure effective aeration after the exposure has ended.

**All standard procedures for fumigating bag-stacks under gas-proof sheets must be applied when loaded freight containers are fumigated with methyl bromide.**

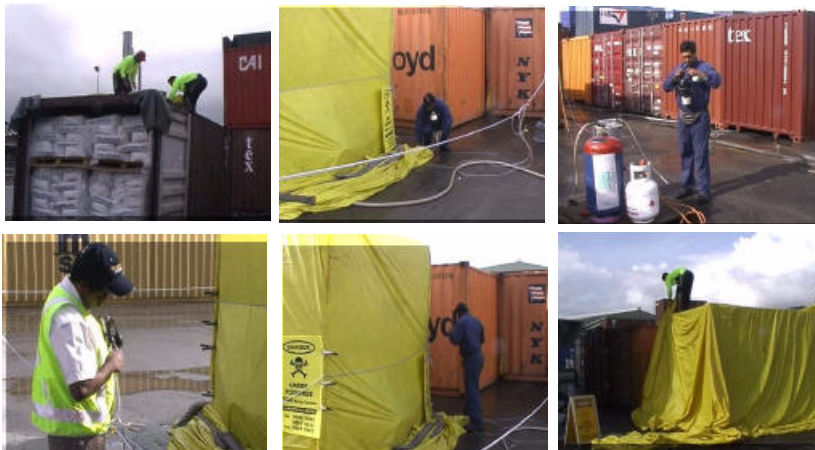

### 9.15 Minimum methyl bromide concentrations and topping-up

During any fumigation treatment carried out with methyl bromide under gas-proof sheets, gas leaks out of the enclosure for many reasons. Factors that may contribute to the rate of leakage include:

- the condition of the fumigation sheet(s)
- how well the sheets are sealed to the floor
- the gastightness of the floor
- wind blowing over and around the enclosure.

It is not possible to accurately predict how much gas will leak or where it will leak from. However, information collected from many



## GUIDE TO FUMIGATION UNDER GAS-PROOF SHEETS

fumigation treatments has shown that about half of the methyl bromide dosage applied can be expected to be lost after 4 hours (see below). This time is called the *half-loss time*.

### Expected concentration of methyl bromide gas during a fumigation treatment under gas proof sheets

Monitoring times	Expected concentration of methyl bromide
0.5 hours	75% or more
1 hour	70% or more
2 hours	60% or more
4 hours	50% or more*
12 hours	35% or more
24 hours	30% or more
48 hours	25% or more

\*The half-loss time

Fumigators must make every effort to extend the half-loss time. It is possible to extend the half-loss time by applying **best fumigation practice**. This would involve one or more of the options available to a fumigator to improve the gastightness of the fumigation enclosure:

- using new sheets, patching holes and tears, joining sheets carefully
- sealing sheets to the floor with a double row of properly filled sand snakes
- making sure the floor of the enclosure is gastight by sealing all expansion joints and cracks, applying gas-proof paint to the floor or using a gastight floor sheet
- performing fumigations in places that are sheltered from wind.

If monitoring shows that:

- gas is being lost from an enclosure, and
- there is a possibility that the fumigation will fail

the fumigator-in-charge can top-up the concentration by adding more methyl bromide to the enclosure. This can be done using the *methyl bromide ready-reckoner* (see page 147).

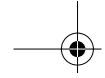

## GUIDE TO FUMIGATION UNDER GAS-PROOF SHEETS

The ready-reckoner covers a range of dosages commonly applied to fumigate grain and other commodities and products.

It provides the fumigator with the following information:

- the expected methyl bromide concentrations (for these dosages) at the seven monitoring times shown on the previous page
- the concentration below which a fumigation will fail; i.e. the threshold for effectiveness
- the concentration to which the methyl bromide can be topped-up to ensure the success of a fumigation treatment.

How is the ready-reckoner used? Let's for example take an enclosure being treated with methyl bromide using a dosage of 32 g/m<sup>3</sup>.

Look at the column starting with 32 g/m<sup>3</sup> in the ready-reckoner.

- The large figures in the middle of each box (24, 22.4, 19.2, 16, 11.2, 9.6, 8) are the *average expected concentrations for a successful treatment at the seven monitoring times*.
- The small figures at the bottom right-hand corner of each box (19, 17.4, 14.2, 11, 6.2, 4.6, 3) are the *concentration values for the threshold for effectiveness at the seven monitoring times*. If monitoring shows that methyl bromide concentrations are below these values **the fumigation is judged to have failed**.
- The small figures at the top left-hand corner of each box (29, 27.4, 24.2, 24, 16.2, 14.6, 13) are the *values up to which the concentration of methyl bromide may be topped up safely at the seven monitoring times*.

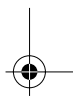
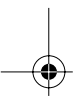
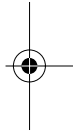



GUIDE TO FUMIGATION UNDER GAS-PROOF SHEETS

**Monitoring Ready-Reckoner**  
Commonly used methyl bromide dosages

Key: 

A = Standard specification (g/m<sup>3</sup>)  
B = Maximum top-up value (g/m<sup>3</sup>)  
C = Minimum concentration (g/m<sup>3</sup>) (top-up required)

Time after start of fumigation	Initial dosage	24g/m <sup>3</sup>	32g/m <sup>3</sup>	40g/m <sup>3</sup>	48g/m <sup>3</sup>	56g/m <sup>3</sup>	64g/m <sup>3</sup>	80g/m <sup>3</sup>	128g/m <sup>3</sup>
0.5 hrs (75% or more of original dose required)	23	18	24	30	36	42	48	60	96
1 hrs (70% or more of original dose required)	21.8	16.8	22.4	28	33.6	39.2	44.8	56	89.6
2 hrs (60% or more of original dose required)	19.4	14.4	19.2	24	28.8	33.6	38.4	48	76.8
4 hrs (50% or more of original dose required)	17	12	16	20	24	28	32	40	64
12 hrs (35% or more of original dose required)	13.4	8.4	11.2	14	16.8	19.6	22.4	28	44.8
24 hrs (30% or more of original dose required)	12.2	7.2	9.6	12	14.4	16.8	19.2	24	38.4
48 hrs (25% or more of original dose required)	11	6	8	10	12	14	16	20	32

\*\* Methyl bromide concentrations less than 3g/m<sup>3</sup> are below the threshold for effectiveness

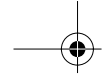

## GUIDE TO FUMIGATION UNDER GAS-PROOF SHEETS

### **Example 1.**

An enclosure being treated with a dosage of  $32 \text{ g/m}^3$  is monitored 4 hours after equilibrium and the concentration of methyl bromide inside the enclosure is found to be  $16 \text{ g/m}^3$ .

This value is exactly 'on standard' for the requirement to retain 50% or more of the original dosage in the enclosure at this time. This allows the fumigator-in-charge to assume that (i) the enclosure is well-sealed and (ii) the fumigation is likely to be successful at the end of the exposure period.

### **Example 2.**

An enclosure being treated with a dosage of  $32 \text{ g/m}^3$  is monitored 12 hours after equilibrium and the concentration of methyl bromide inside the enclosure is found to be  $8 \text{ g/m}^3$ .

This value is:

- below the requirement to retain 35% ( $11.2 \text{ g/m}^3$ ) or more of the original dosage in the enclosure at this time
- but above the  $6.2 \text{ g/m}^3$  threshold for effectiveness.

This means the fumigator-in-charge has the option to top-up the concentration to be sure that the endpoint concentration of  $9.6 \text{ g/m}^3$  required at 24 hours is achieved.

If this option is selected, the amount of gas required to top-up the concentration is calculated as follows:

- concentration at time of monitoring =  $8 \text{ g/m}^3$
- the concentration up to which it is safe to top-up is  $16.2 \text{ g/m}^3$
- amount of gas required to top-up =  $16.2 - 8 = 8.2 \text{ g/m}^3$ .

The amount of gas required to top-up the enclosure is:

**$8.2 \text{ grams} \times \text{the total volume (m}^3\text{) of the enclosure.}$**

### **Example 3.**

An enclosure being treated with a dosage of  $32 \text{ g/m}^3$  is monitored 24 hours after equilibrium and the concentration of methyl bromide inside the enclosure is found to be  $3 \text{ g/m}^3$ .



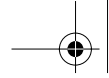

## GUIDE TO FUMIGATION UNDER GAS-PROOF SHEETS

This value is:

- below the requirement to retain 30% ( $9.6 \text{ g/m}^3$ ) or more of the original dosage in the enclosure at this time
- and also below the  $4.6 \text{ g/m}^3$  threshold for effectiveness.

This means the top-up option cannot be used, because the fumigation has failed.

In this case, the fumigator-in-charge must ventilate the enclosure and, when the gas concentration has fallen to, or below, the TLV, investigate the reason for failure before attempting to re-fumigate.

### **Example 4.**

An enclosure being treated with a dosage of  $32 \text{ g/m}^3$  is monitored 24 hours after equilibrium and the concentration of methyl bromide inside the enclosure is found to be  $5 \text{ g/m}^3$ .

This value is:

- below the requirement to retain 30% ( $9.6 \text{ g/m}^3$ ) or more of the original dosage in the enclosure at this time
- but above the  $4.6 \text{ g/m}^3$  threshold for effectiveness.

This means the fumigator-in-charge has the option to top-up the concentration. If this option is selected, the amount of gas required to top-up the concentration is calculated as follows:

- concentration at time of monitoring =  $5 \text{ g/m}^3$
- the concentration up to which it is safe to top-up is  $14.6 \text{ g/m}^3$
- amount of gas required to top-up =  $14.6 - 5 = 9.6 \text{ g/m}^3$ .

In this case, the amount of gas required to top-up the enclosure is:  
 **$9.6 \text{ grams} \times \text{the total volume (m}^3\text{) of the enclosure.}$**

Whenever the top-up option is used at the end of the exposure period, it is necessary to:

- extend the exposure period by four (4) hours
- monitor the concentration at the end of this four hour period.

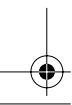
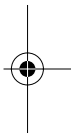
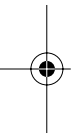



## GUIDE TO FUMIGATION UNDER GAS-PROOF SHEETS

If, at this time, the value is:

- at or above the required endpoint concentration of 9.6 g/m<sup>3</sup> the fumigation is judged to have been successful
- below required endpoint concentration of 9.6 g/m<sup>3</sup> the fumigation is judged to have failed.

**Fumigators should use the top-up option with care. A number of factors must be considered before it is used, including workspace and environmental effects, cost of methyl bromide, and excessive residues.**

### 9.16 Methyl bromide and the ozone layer

The ozone layer high in the atmosphere (10–50 km above the Earth's surface) is very important for life on earth, because it stops harmful ultraviolet radiation reaching ground level.

It has been shown that exposure to too much harmful ultraviolet radiation is linked to skin cancer and eye disease in humans, reduced yields in some food and agricultural crops, and other problems that may affect life on Earth.

Methyl bromide can break down ozone in the Earth's atmosphere, resulting in too much harmful ultraviolet radiation reaching the Earth's surface. As a result, internationally agreed timetables have been established (through the Montreal Protocol) to control, and eventually phase-out, use of methyl bromide.

Fumigators must be aware of the phase-out process and how it will affect their ability to use methyl bromide after it has been phased-out completely. The process is shown in the following table.





**GUIDE TO FUMIGATION UNDER GAS-PROOF SHEETS**

THE METHYL BROMIDE PHASE-OUT PROCESS			
Industrialised (or developed) countries		Developing countries	
25% reduction	1999		
50% reduction	2001		
		<b>Freeze</b> use of methyl bromide	2002
70% reduction	2003	<b>Review</b> interim reductions	2003
<b>TOTAL PHASE-OUT</b>	2005	<b>20%</b> reduction in use	2005
		<b>TOTAL PHASE-OUT</b>	2015*

\* This date is subject to review.

Fumigators must be aware that two uses of methyl bromide are specifically exempted from these controls:

- quarantine uses
- pre-shipment use.

These two uses have been strictly defined.

**Alternatives to methyl bromide for grain and commodity storage**

***Phosphine***

Phosphine, which is widely registered for use throughout the world, is the only fumigant gas that is immediately available as an alternative to methyl bromide.

It is important to understand that the exposure periods required for successful fumigation with phosphine are much longer than those required for methyl bromide. This means that it is essential to:

- make sure that fumigation enclosures are well-sealed and gastight
- make sure phosphine concentrations are maintained at insecticidal levels over the whole of the exposure period, which may extend for 7–10 days or even longer.

However, long-term use of phosphine is threatened by the development of insect resistance to it. Such resistance has been detected in several countries. This will require greater and on-going

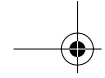

## GUIDE TO FUMIGATION UNDER GAS-PROOF SHEETS

---

management interest in fumigation in the form of quality-control systems, training, record keeping, and implementation of **best fumigation practice** when using this fumigant.

### *Sheet fumigation with phosphine*

Exposure periods can be extended by simple improvements to sealing methods used to ensure gastightness during sheet fumigation. These improvements include: well-sealed floors, use of new fumigation sheets that are gastight, and effective sealing with wide or doubled sand snakes (Taylor and Harris 1994; Bengston et al. 1997).

These and other simple improvements to the technique of sheet fumigation, must be managed as standard **best fumigation practice** wherever phosphine is used.

### *Sealed-stack storage with phosphine*

A new technique for bag-stacked grain is the sealed-stack (van S. Graver and Annis 1994) storage and fumigation system which has been extensively tested using phosphine in Southeast Asia. The technique is available for immediate adoption as an alternative to methyl bromide.

An operational feature of the sealed-stack system is the ability to pressure-test the sealed enclosures. This provides a practical and accurate means of predicting the outcome of a fumigation in terms of gastightness and potential for fumigant retention, something which is impossible with conventional sheet fumigation. The technique is used in the Philippines as a standard option for storage of milled rice and is available for immediate adoption.

### **Controlled atmospheres**

Controlled atmospheres are available for use as alternatives to methyl bromide. Application techniques have been developed that allow them to be used with grain stored in bags. Controlled atmospheres can be divided into two general classes depending on how they are created:





## GUIDE TO FUMIGATION UNDER GAS-PROOF SHEETS

- high carbon dioxide (CO<sub>2</sub>), in which carbon-dioxide concentrations are increased to approximately 70–80%
- low oxygen (O<sub>2</sub>), where the oxygen concentration is reduced to 1% or less.

High carbon dioxide controlled atmospheres are more commonly used for disinfestation than nitrogen-based, low-oxygen controlled atmospheres because:

- they are effective over a larger concentration range
- they can usually be applied in a 'single shot' (unlike low-oxygen controlled atmospheres)
- there is a greater need for gastightness when using low-oxygen atmospheres.

The exposure periods required for controlled atmospheres are much longer than those required for methyl bromide, which makes them unsuitable when rapid disinfestation is required.

### *Sealed-stack storage with controlled atmospheres*

Controlled atmospheres can be used at atmospheric pressure to disinfest bagged commodities using the sealed-stack technique (Annis and van Graver 1991). The technique requires a high level of sealing to maintain carbon dioxide at the required concentration over a minimum 15-day exposure period under tropical conditions. These requirements have been regularly, and easily, achieved in commercial practice. The requirement for a 15-day exposure period for effective disinfestation places greater emphasis on stock control, management and logistics.

The technique is used in Indonesia and Vietnam as a standard option for storage of milled rice and is available for immediate adoption.

This technique offers an approved means for 'non-chemical' disinfestation of bagged organic and biodynamic grains, which are becoming increasingly important in overseas markets. Also, in countries where admixture of grain-protectant chemicals is prohibited, sealed stacks treated with carbon dioxide can provide a feasible alternative to phosphine.

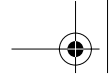

## GUIDE TO FUMIGATION UNDER GAS-PROOF SHEETS



### ***Hermetic storage***

Hermetic storage (Varnava et al. 1995; Anon. 2002) has been used to store grain for thousands of years, and this ancient technique is still in widespread use in subsistence agriculture, using naturally available materials for construction. The modern approach to the use of hermetic storage relies on welded plastic gastight liners to provide the hermetic storage enclosure.

During hermetic storage, grain and other food commodities are placed in hermetically sealed enclosures that prevent air from entering or leaving them.

Inside the enclosure, the natural respiration of the grain, together with that of any associated insects and fungi, does two things: (i) it reduces the oxygen content, and (ii) it raises the carbon dioxide content to insecticidal levels. These effects control or eliminate insect infestation. The process works better with warm, well-dried grain.

The process is simple, self-regulating, and requires no added pesticides, fumigants, controlled atmospheres, or other energy input.

Semi-underground hermetic storage structures were successfully used to store grain in Argentina during the 1940s, and later in Cyprus and Kenya from the 1950s to the 1970s.

Modern, well-sealed, plastic hermetic enclosures (Grain Pro 2004) allow grain to be stored safely, remain fresh, free of insect infestation,

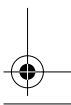
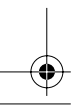
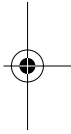



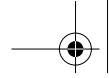

## GUIDE TO FUMIGATION UNDER GAS-PROOF SHEETS

---

and maintain the ability to germinate. Such structures are widely used around the world to store beans, cocoa, coffee (green), CSM, dried chillies, flour, maize, milk powder, millet, paddy, pulses, rice (milled), seeds, sorghum, teff, wheat, and wheat bran.

Hermetic storage also offers a means for 'non-chemical' disinfestation of bagged organic and biodynamic grains and can be applied in countries where admixture of grain-protectant chemicals is prohibited.

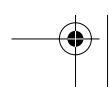
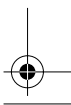
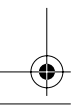
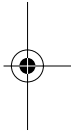



## 10 AERATION AND CLEARANCE AFTER A FUMIGATION

At the end of the exposure period, the amount of gas remaining inside the fumigation enclosure and in the danger area, must be reduced to a level at which it is safe for workers to handle the fumigated product. This must be done because, in a successful fumigation, the concentration of methyl bromide or phosphine remaining inside the enclosure will kill human beings. These areas can be declared 'safe to enter' only after fumigant gas levels have fallen to, or are below, the TLV for the fumigant used. Only after this has been done must the fumigator-in-charge allow any person to enter the warehouse and handle the product that was fumigated.

The first stages of the process of airing an enclosure are possibly the most dangerous part of the fumigation process. Because of this, respiratory protection must be worn at all times by all people involved in the aeration process, until the fumigant can no longer be detected above the TLV in:

- the free air around the treated commodity
- the enclosure
- the warehouse or building where the fumigation was done.

The order and speed of aeration must be decided by the fumigator-in-charge after considering factors including the:

- concentration of fumigant inside the enclosure
- volume of the enclosure and the warehouse in which the fumigation was made
- wind speed and direction
- nearness of buildings in which people live.

Where large stacks have been enclosed under more than one gas-proof sheet, the process of opening the enclosure must be gradual, with alternate periods of work and ventilation, until concentrations in the stacks are low enough to permit safe removal of all sheets. Fans should



## GUIDE TO FUMIGATION UNDER GAS-PROOF SHEETS

be used (wherever possible) to ensure maximum ventilation of the working area to disperse the gas. The atmosphere in the danger area and fumigation enclosure must be tested regularly by the fumigator-in-charge until the gas concentration has fallen below the TLV.

Special attention must be given to sorbent materials that can sometimes desorb gas for a long time after the enclosure has been opened for aeration.

### 10.1 Clearing the fumigant from the enclosure

Fumigators wearing respiratory protection (gas masks fitted with appropriate filters) or self-contained breathing apparatus:

1. enter the danger area
2. open all doors, windows and ventilators to allow free air movement
3. **switch on fans** if any are installed (either permanently or brought in specifically for the fumigation)
4. remove enough sand snakes from around one corner of the enclosure so that the fumigation sheet is free to be lifted **then,**
5. using a ladder, at least two fumigators climb to the top of the enclosure taking a length of rope with them
6. a fumigator at the bottom of the stack fastens one end of the rope to the corner of the fumigation sheet
7. the two fumigators at the top of the enclosure pull up the rope (taking care not to tear the sheet) until the bottom of the sheet has been lifted to the top of the enclosure so that the corner of the stack is exposed. The sheet is held on top of the enclosure by:
  - weighting down the sheet with a bag of grain or several sand snakes, or
  - fastening the rope to a roof truss.
8. the two fumigators at the top of the enclosure/stack climb down the ladder and together with their colleagues now leave the danger area. They now remove their respiratory protection.



## GUIDE TO FUMIGATION UNDER GAS-PROOF SHEETS

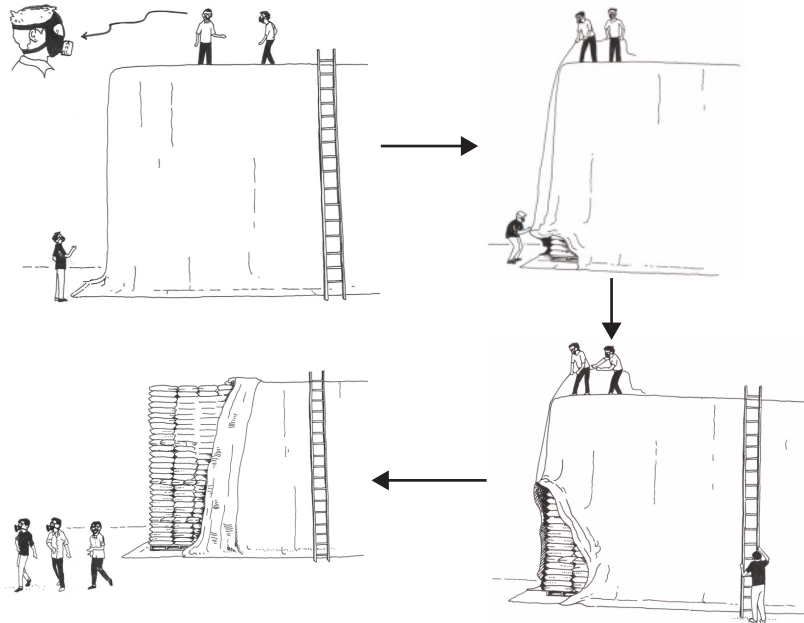

9. They must remove their respiratory-protection equipment only when they are outside the danger area.
10. With large enclosures (where more than one sheet has been used), this procedure may have to be repeated at intervals to increase aeration by:
  - unrolling and separating joined sheets.
11. Fans can be used to speed up the aeration process. However, the concentration of fumigant gas must still be measured before declaring the fumigation area safe to enter and/or handle the fumigated product.

**To minimise worker exposure to desorbing fumigant gases, start the aeration process at the end of the working day and continue overnight, whenever possible.**

**Some highly sorptive products (e.g. flour, oilseeds, expeller cake) may require considerably longer aeration times before they are safe to handle.**



## GUIDE TO FUMIGATION UNDER GAS-PROOF SHEETS

12. It is not possible to accurately predict how long the aeration period will last. However, it must be noted that:
- it usually takes longer to aerate a commodity after it has been fumigated with methyl bromide than after a fumigation with phosphine
  - aeration by natural ventilation can sometimes take 5 days.

**Using natural ventilation, more than 60 hours may be needed to aerate methyl bromide out of tightly packed 40-ft freight containers.**

13. The decision to declare the area safe to enter is made by the fumigator-in-charge, who has tested the air in the workspace, using a low-range gas detector suitable for workspace or environmental levels of the fumigant used, and made sure that the concentration of fumigant gas has fallen to or below the TLV, which for:
- **phosphine** is 0.3 ppm (0.4 mg/m<sup>3</sup>)
  - **methyl bromide** is 5 ppm (0.02 g/m<sup>3</sup>).

**With phosphine, absence of smell does not mean there is no gas present.**

14. When these levels are reached, the fumigator-in-charge may then issue a certificate of clearance to the owner of the warehouse when satisfied that the area is safe for people to enter and handle the fumigated product.
15. After the danger area has been declared safe, the fumigator-in-charge must:
- make sure all fumigation-danger signs have been removed
  - return to the owners the keys of the warehouse where the fumigation was done



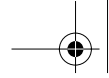

## GUIDE TO FUMIGATION UNDER GAS-PROOF SHEETS

---

- inform all national and local government agencies that may be involved (for example, the police, the fire brigade, the nearest hospital etc.), that the fumigation has been completed.
16. Treated commodities may be safely transported after completion of the recommended aeration period, but not before the certificate of clearance has been issued.
17. Where national or local government regulations require a *withholding period* after fumigation this must be observed.
- Where there is no recommended withholding period, commodities for human consumption or stock feed must not be used before 48 hours after completion of ventilation.

### 10.2 Clearing fumigant from fumigation equipment

#### *Treatments with methyl bromide*

Vaporisers, piping, and other equipment used during a fumigation done with methyl bromide must be blown out with compressed air in a well-ventilated safe place, before being stored or transported.

This is especially important where chloropicrin has been added to methyl bromide as a warning agent. This is because chloropicrin may condense, and if not removed can become a serious and unexpected safety hazard.

It is recommended that all fumigation sheets be aired for at least two hours before rolling for storage and future use.

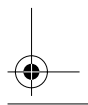
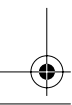
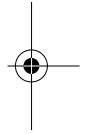

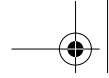

## 11 FUMIGATION FAILURE

In the event of fumigation failure, every effort must be made to find out the cause of the failure. A leaky enclosure is frequently the cause.

Before attempting further fumigation with phosphine, this or any other problem must be made good. Alternatively, other treatments should be used.

**Higher dosage rates of phosphine will not compensate for poor gastightness.**

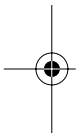

### 11.1 Some reasons why phosphine fumigations fail



1. Tears and punctures in fumigation sheets were not repaired, allowing gas to leak.
2. Fumigation sheets were not properly sealed to the floor of the enclosure, allowing gas to leak.
3. The enclosure was built around pillars or roof supports, allowing gas to leak.
4. The floor of the enclosure was not gastight, allowing gas to leak.
5. The floor of the enclosure was rough or uneven, preventing a gastight seal to be made and allowing gas to leak.
6. The fumigation sheet was not properly folded at floor level or at corners of the enclosure, allowing gas to leak.
7. Fumigation sheets were not joined to provide a gastight seal, allowing gas to leak.
8. There was not enough space between the stack and the warehouse wall, preventing a good seal being made between the floor and fumigation sheets, allowing gas to leak.

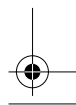
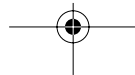
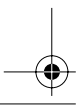



## GUIDE TO FUMIGATION UNDER GAS-PROOF SHEETS

9. There was an open floor drain or large joint in the concrete floor under the stack, allowing gas to leak.
10. The dosage was incorrect:
  - an incorrect amount of gas was applied, or the volume of the enclosure was not measured correctly
  - the exposure period was not long enough to kill all life stage of all target insect pests. *Below 25°C, some species of insects and mites require exposure periods longer than 10 days for a complete kill of all life stages.*
11. Lightweight rolled bags were used instead of heavy sand snakes, allowing gas to leak.
12. Sand snakes were laid in a single row, instead of two, overlapped rows, allowing gas to leak.
13. Leak detectors and/or gas-monitoring instruments were not used during the exposure period, allowing gas to leak undetected.
14. The fumigation was done at temperatures below 15°C.
15. The fumigation was carried out under windy conditions.
16. The product was reinfested from another source of infestation inside the warehouse after the fumigation sheets were removed.

### 11.2 Some reasons why methyl bromide fumigations fail

1. The wrong type of sheet, e.g. 125 g/m<sup>2</sup> LDPE, was used.
2. Tears and punctures in the fumigation sheets were not repaired, allowing gas to leak.
3. The fumigation sheets were not properly sealed to the floor of the enclosure, allowing gas to leak.
4. The enclosure was built around pillars or roof supports, allowing gas to leak.
5. The floor of the enclosure was not gastight, allowing gas to leak.
6. The floor of the enclosure was rough or uneven, preventing a gastight seal to be made and allowing gas to leak.
7. The fumigation sheet was not properly folded at floor level or at the corners of the enclosure, allowing gas to leak.





## GUIDE TO FUMIGATION UNDER GAS-PROOF SHEETS

8. The fumigation sheets were not joined to provide a gastight seal, allowing gas to leak.
9. There was not enough space between the stack and the warehouse wall, preventing a good seal being made between the floor and the fumigation sheets, allowing gas to leak.
10. There was an open floor drain or large joint in the concrete floor under the stack, allowing gas to leak.
11. There was no check for leaks at the start of the exposure period.
12. Fans were not used to mix and distribute gas inside the enclosure.
  - Methyl bromide is more than three (3) times heavier than air. Unless mixed, it may settle with very high concentrations at floor level and low (sometimes undetectable) concentrations at the top of the enclosure.
13. The dosage was incorrect.
  - An incorrect amount of gas was applied, or the volume of the enclosure was not measured correctly.
  - The exposure period was not long enough to kill all life stages of all target insect pests.
14. Lightweight rolled bags were used instead of heavy sand snakes, allowing gas to leak.
15. Sand snakes were laid in a single row instead of in two overlapped rows, allowing gas to leak.
16. Leak detectors and/or gas-monitoring instruments were not used, allowing gas to leak undetected during the exposure period.
17. The fumigation was done at temperatures below 10°C.
18. The fumigation was done under windy conditions.
19. The product was reinfested from another source of infestation inside the warehouse after the fumigation sheets were removed.



## 12 REFERENCES

### 12.1 Selected world-wide-web-based references (accessed 15 May 2004) at:

AgriQuality. Dosimeter sachets. At: <[http://www.agriquality.com/general\\_information.cfm](http://www.agriquality.com/general_information.cfm)>

Anon. 2002. Hermetic storage. At: <<http://www.agri.gov.il/Envir/hermetic/hermetic.html>>.

Bond, E.J. 1984. Manual of fumigation for insect control. FAO Plant Production and Protection Paper 54, Food and Agriculture Organization of the United Nations, Rome, Italy. At: <<http://www.fao.org/inpho/isma?m=gsearch&txt=fumigation&i=INPhO&p=SimpleSearchDetail&lang=en&pg=1&n=4>>.

The Chemo Electronic Laboratory. Dosimeter tubes. At: <[http://www.chemo-electronic.com/html/Dosimeter\\_Tubes.htm](http://www.chemo-electronic.com/html/Dosimeter_Tubes.htm)>

Degesch America Inc. Phosphine: material safety data sheets. At: <<http://www.degeschamerica.com/download.html>>.

GrainPro. Hermetic storage. At: <<http://www.grainpro.com/>>.

Great Lakes Chemical Corporation. Methyl bromide fumigation guide. At: <<http://www.e1.greatlakes.com/agproduct/pdf/FUMIGATI.PDF>>.

Great Lakes Chemical Corporation. Methyl bromide: material safety data sheets. At: <<http://www.glcc-agproducts.com/commodity.html>>.

Health Canada. Fumigation module. Basic knowledge requirements for pesticide education in Canada. At: <[http://www.hc-sc.gc.ca/pmra-arla/english/pdf/edu/edu\\_applicator-e.pdf](http://www.hc-sc.gc.ca/pmra-arla/english/pdf/edu/edu_applicator-e.pdf)>.

FAO Information Network on Post-harvest Operations. At: <<http://www.fao.org/inpho/isma?i=INPhO&p=index.jsp&lang=en>>.

MBTOC 1995. 1994 assessment report of the Methyl Bromide Technical Options Committee. At: <<http://www.teap.org/TEAP%20SITES/TEAP/REPORTS/REPORTS%20DOWNLOADS/MBTOC94.pdf>>.

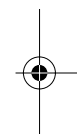



## GUIDE TO FUMIGATION UNDER GAS-PROOF SHEETS

---

MBTOC 1998. 1998 assessment report of the Methyl Bromide Technical Options Committee. At: <<http://www.teap.org/TEAP%20SITES/TEAP/REPORTS/REPORTS%20DOWNLOADS/MBTOC98.pdf>>.

MBTOC 2002. 2002 assessment report of the Methyl Bromide Technical Options Committee. At: <<http://www.teap.org/TEAP%20SITES/TEAP/REPORTS/REPORTS%20DOWNLOADS/MTOC2002.pdf>>.

United Phosphorus Inc. Phosphine. Weevil-Cide® Pellets. 2002 applicators manual. At: <<http://www.cdms.net/manuf/1prod.asp?pd=3842&lc=0>>.

## 12.2 Selected printed references

AFHB/ACIAR 1989. Suggested recommendations for the fumigation of grain in the ASEAN region. Part 1 Principles and general practice. Kuala Lumpur, AFHB/Canberra, ACIAR, 131 p. ISBN 967-9932-11-7. (Also available in Bahasa Indonesia and Mandarin.)

Annis, P.C. and van S. Graver, J. 1991. Suggested recommendations for the fumigation of grain in the ASEAN region. Part 2 Carbon dioxide fumigation of bag-stacks sealed in plastic enclosures: an operations manual. Kuala Lumpur, AFHB/Canberra, ACIAR, 58 p. ISBN 967-9932-19-2. (Also available in Bahasa Indonesia and Mandarin.)

Anonymous. 1974. Fumigation with methyl bromide under gas proof sheets. Ministry of Agriculture, Fisheries and Food, UK, 56p.

Anonymous. 1981. Australian standard. General fumigation procedures; AS 2476-1981. Standards Association of Australia, North Sydney, NSW, 12p. ISBN 0 7262 2297 6.

Australian Quarantine and Inspection Service. The AQIS standard for methyl bromide fumigation. Version 1.2, March 2001

Bengston, M., Sidik, M., Halid, H. and Alip, E. 1997. Efficacy of phosphine fumigations on bagged milled rice under polyethylene sheeting in Indonesia. In: Donahaye, E.J., Navarro, S. and Varnava, A., Eds. Proceedings of the International Conference on Controlled Atmosphere and Fumigation in Stored Products, 21-26 April 1996, Nicosia, Cyprus, 225-233. ISBN 9963-8202-0-4.

Bond, E.J. 1984. Manual of fumigation for insect control. FAO Plant Production and Protection Paper No. 54, 432p.

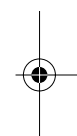



## GUIDE TO FUMIGATION UNDER GAS-PROOF SHEETS

- Chaudhry, M.Q., Ahmed, H. and Anwar, M. 1989. Development of an airtight polyethylene enclosure for integrated pest management of grains, stored at farm level in Pakistan. *Tropical Science*, 29, 177–187.
- Dow AgroSciences 1998. Structural fumigation manual for use with Vikane gas fumigant. Dow AgroSciences LLC, Speciality Products, 9330 Zionsville Rd, Indianapolis, IN 46268 - 1054, USA.
- Friendship, R. 1989. Fumigation with phosphine under gas proof sheets. *Overseas Development Natural Resources Institute Bulletin*, No 26, ii + 22p. ISBN 0 85954 254 8. ISSN 095 8254.
- Natural Resources Institute. Poster: Successful fumigation under gas-tight sheets with phosphine. Natural Resources Institute, Central Avenue, Chatham Maritime, Kent ME4 4TB, UK.
- Natural Resources Institute. Video: Good fumigation practice using phosphine. Natural Resources Institute, Central Avenue, Chatham Maritime, Kent ME4 4TB, UK.
- Rajendran, S. 2000. Sheeted bag stack fumigation with phosphine. *Pesticide Outlook*, 11, 92–93. ISSN 0030-7270.
- Rajendran, S. 2001. Insect resistance to phosphine – challenge and strategies. *International Pest Control*, 43, 118–123. ISSN 0020 8256.
- Semple, R.L. and Kirenga, G.I. 1994. Facilitating regional trade of agricultural commodities in eastern, central and southern Africa. Dar es Salaam University Press, Tanzania.
- Taylor, R. and Gudrups, I. 1996. Using phosphine as an effective commodity fumigant. Natural Resources Institute, Chatham, UK, Booklet No. PES2. 14p. ISBN 0-85954-437-0.
- Taylor, R.W.D. and Harris, A.H. 1994. The fumigation of bag-stacks with phosphine under gas proof sheets using techniques to avoid the development of insect resistance. In: Highley, E., Wright, E.J. Banks, H.J. and Champ, B.R. Eds. *Stored product protection. Proceedings of the 6th International Working Conference on Stored-product Protection, Canberra*. CAB International, Wallingford, UK, 1, 210-213. ISBN 0 85198 932 2.
- van S. Graver, J. and Annis, P.C. 1994. Suggested recommendations for the fumigation of grain in the ASEAN region. Part 3 Phosphine fumigation of bag-stacks sealed in plastic enclosures: an operations manual. Kuala Lumpur, AFHB/Canberra, ACIAR, 79p. ISBN 967-9932-21-4. (Also available in Bahasa Indonesia and Mandarin).

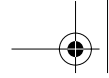

---

### GUIDE TO FUMIGATION UNDER GAS-PROOF SHEETS

---

Varnava, A., Navarro, S. and Donahaye, E. 1995. Long-term hermetic storage of barley in PVC-covered concrete platforms under Mediterranean conditions. *Postharvest Biology and Technology*, 6, 177–186.

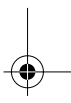
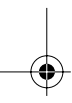
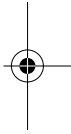

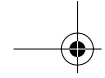

## 13 ACKNOWLEDGMENTS

This printed fumigation guide complements a CD-ROM with the same title. It includes extracts from unpublished texts written by Mr Peter Annis (CSIRO Entomology, Canberra, Australia), Dr Pat Collins and Dr Greg Daglish (Queensland Department of Primary Industries, Brisbane, Australia), and Mr Vern Walter (WAW Inc., Texas, USA). Permission to use these extracts is gratefully acknowledged.

Permission to use material from publications of the Australian Quarantine and Inspection Service (AQIS), Dow AgroSciences (USA), and the Natural Resources Institute (UK) is likewise acknowledged.

I am grateful for reviews of this guide undertaken by the persons listed below. Their comments and suggestions have served to improve its content and presentation.

Dr Chris Bell, Central Science Laboratory, York, England.

Dr Bruce Champ, formerly Australian Centre for International Agricultural Research, Canberra, Australia.

Dr Pat Collins, Queensland Department of Primary Industries, Brisbane, Australia.

Mr Patrick Ducom, Ministère de l'Agriculture, Laboratoire des Denrées Stockées, Cenon, France.

Dr Paul Fields, Agriculture and Agri-Food Canada, Winnipeg, Canada.

Dr Rick Hodges, Natural Resources Institute, Chatham, England.

Dr Shlomo Navarro, Agricultural Research Organisation, Bet Dagan, Israel.

Dr Somiah Rajendran, Central Food Technological Research Institute, Mysore, India.

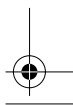
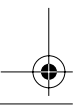
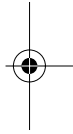

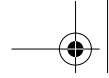

## GUIDE TO FUMIGATION UNDER GAS-PROOF SHEETS

---

Dr Christoph Reichmuth, Federal Biological Research Centre for Agriculture and Forestry, Institute for Stored Product Protection, Berlin, Germany.

Dr Gerard Schulten, formerly FAO, Rome.

Mr Lindsay Semple, Kompong Song, Cambodia.

Dr Bob Taylor, Natural Resources Institute, Chatham, England.

Mr Vern Walter, WAW Inc., Leakey, Texas, USA.

Dr Chris Whittle, CSIRO Entomology, Canberra, Australia.

Dr Bob Winks, formerly CSIRO Entomology, Canberra, Australia.

The still and video images used in the CD-ROM and in this printed guide were created, provided, or made on the premises, of the following persons or organisations, who have allowed them to be used here:

Mrs Betty Allibone, Fumigate All Hours, Sydney, Australia.

Mr Simon Ball, Australian Fumigation Pty Ltd, Port Adelaide, Australia.

Dr Greg Daghish, Queensland Department of Primary Industries, Brisbane, Australia.

Mr Brett Hatherly, BH Graphics, Canberra, Australia.

Dr Barry Longstaff, University of New South Wales, Sydney, Australia.

Mr Peter Meadows, Peter Meadows Consulting Pty Ltd, Newport Beach, NSW, Australia.

Mr Soussanith Nokham, CSIRO Entomology, Canberra, Australia.

Mr Jan van Someren Graver, CSIRO Entomology, Canberra, Australia.

Dr Rashid Qaisrani, CSIRO Entomology, Canberra, Australia.

Mr Vern Walter, WAW Inc., Texas, USA.

The Australian Quarantine and Inspection Service (AQIS), Canberra, Australia.

The Bureau of Postharvest Research and Extension (BPHRE), Muñoz, Nueva Ecija, Philippines.

CSIRO Entomology, Canberra, Australia.

Natural Resources Institute, Chatham Maritime, Kent, UK.

The National Logistics Agency (BULOG), Jakarta, Indonesia.

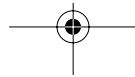
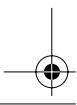
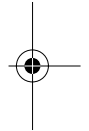
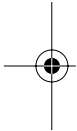

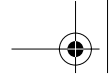

## GUIDE TO FUMIGATION UNDER GAS-PROOF SHEETS

---

Many 'old fumigators' have, over many years, made me welcome in their countries and very generously shared their knowledge and experience with me. I thank these people for their practical input into this guide.

I appreciate and am grateful for the on-going support for this project provided by Bruce Champ, Greg Johnson, Ed Highley, and Barry Longstaff.

The text of this guide was compiled by Mr Jan van Someren Graver (CSIRO Entomology, Canberra, Australia).

Dr Barry Longstaff (University of New South Wales, Sydney, Australia) transformed the text into the complementary, multimedia interactive CD-ROM incorporating high-quality images and video.

J.E. van Someren Graver  
CSIRO Entomology  
Stored Grain Research Laboratory  
GPO Box 1700  
Canberra ACT 2601  
Australia

